

Buyer's Guide

2025



EARLY ORDER DISCOUNTS

8% Cash discount on orders from **Dec 1 - Jan 10, 2025**

John Deere Credit Net 180 **Jan 10, 2025**

4% discount on orders from **Jan 13 - 31, 2025**

3% discount on orders in **February, 2025**





Dear Customers,

We want to take a moment to thank all our loyal customers, whether you have been with us through the years, or joined our family a short time ago. We need and appreciate each and every one of you! Here at Martin's Produce Supplies we strive for customer satisfaction. If we can approve in any way please let us know, because a happy customer is a returning customer. So again, we say thanks for your patronage and we hope that if you have never worked with us, that you may give us a opportunity. May God bless your year, The MPS Family.

Hours of Operation

Weekdays	Saturday and Sunday
Year round	Closed
7:00 AM - 5:00 PM	
Mon - Fri	

Payment Terms

We offer credit cards, debit cards, COD, check in advance, John Deere Financing, or Farm Credit Express.



Why Use Farm Credit Express?

- Easy, on-the-spot financing
- Allows you to take advantage of cash discounts from manufacturer for new equipment
- Used equipment programs
- Decisions within minutes
- Fixed rate loan products
- Leasing options
- Service and support from a local lender
- The opportunity to share in our profit-sharing patronage program

Major Credit Cards Accepted



Location & Directions

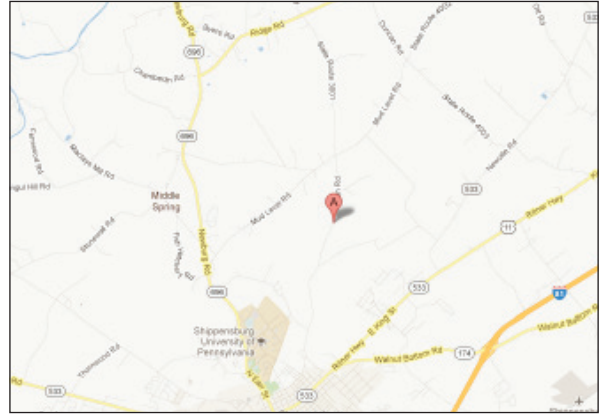

From I-81

Take exit 29 for PA-174/King St - 0.2 miles
 Take PA-174 West into Shippensburg - 1.5 miles
 Turn left onto PA-11/PA-533/King St & continue for 0.3 miles
 Turn right onto North Queen St (at Sheetz) - 0.2 miles
 Turn right onto Britton Rd - 1.9 miles
 We are located on the right side.

Holiday Observance

Closed the following holidays:

- New Years - January 1
- Good Friday - April 18
- Ascension Day - May 29
- Labor Day - September 1
- Thanksgiving - November 27
- Christmas - December 25

Competitive Shipping Rates



If you need a specific shipping carrier, Please call us to arrange shipping.

When shipping LTL Motor Freight, we broker with various shipping carriers to find you the best possible rates.

TABLE OF CONTENTS

Most equipment and pumps have a two year warranty. Warranty is provided directly from the manufacturer to you as the customer. Please contact the manufacturer to claim a warranty.

Product specifications and availability are subject to change without notice and substitute items may occasionally be shipped.

We recommend you to mail, or fax your orders in a minimum of two weeks before you pick up them up, or need to be shipped. We reserve the right to pro-rate items in short supply. Prices are not guaranteed.

Early orders placed and not picked up by Feb. 15 will be subject to available supplies and updated Prices.

Order onion sets early and pickup on or before our indicated pickup date to avoid spoilage.

Returns policy: Salable products in their original packaging may be returned with permission. (10% restocking charges apply).

Note: Seeds, onion sets, fertilizer, special order items, and discounted items not returnable under any condition.

Credit refunds: In case of over payments, shortages, etc. credit invoices will be issued and expire after one year.

All claims for damaged and missing items on a order MUST be made within 5 days from receiving the shipment. A signed proof of deliver noting the damage or missing items must be included. We will not be honoring any claim issues after the 5 days. This would also apply to any orders picked up at our warehouse, customer is required to verify all items on the order within 5 days.



Heaters, Fans & Shutters	5
Pots & Containers	6-8
Seeds	9-29
Fertilizers	30-39
Chemicals	39-47
Irrigation	48-56
Controllers	57-58
Pumps	59-60
Filters	61
Injectors	62-63
Fittings	64-77
Hosing & Pipe	78-79
Drip Tape	80-81
Mulch Bed Planters	82-84
Mulch Plastic	85
Transplanters	86
Sprayers	87-91
Conveyors	92-95
Mulch Lifter	96
Bird Scare Products	97
Produce Supplies	98-111



January 15 & 16, 2025

at Spooky Nook

75 Champ Blvd. Manheim, PA

More exhibitors. Larger meeting rooms.

**Two days of seminars for Cut Flowers,
Greenhouse and Produce Growers.**

For a registration form, go to
thefamilyfarmresource.com/crop-growing-expo
or contact the show office.

Questions? Contact the show office at 717-690-1081
or cropgrowingexpo@gmail.com.

\$40 REGISTRATION (per person for both days)
\$30 Early bird registration (before December 15)



Ground & Row Covers

Black Woven Ground Cover

This is a UV stabilized black woven cloth that is extremely strong and superior to sheet plastic. 3.2oz with a stripe every 12". Call for quantity discounts. **The rolls of 10.5, 12.5, and 15.5 now come folded for ease of transporting and handling**



ITEM #	DESCRIPTION	PRICE	10+
BGC03	3' x 300' Black Ground Cover	41.23	\$45.34
BGC04	4' x 300' Black Ground Cover	54.97	\$60.48
BGC06	6' x 300' Black Ground Cover	82.45	\$90.70
BGC10	10.5' x 300' Black Ground Cover (Folded)	144.29	\$148.89
BGC12L	12.5' x 300' Black Ground Cover (Unfolded)	173.87	\$177.24
BGC15L	15.5' x 300' Black Ground Cover (Unfolded)	212.99	\$219.78

Spring Steel Hoops

A .120" gauge spring steel hoop for use with a mechanical tunnel layer, to hold up row cover over the crop. Sold in 100 quantity bundle.



ITEM #	LENGTH	LBS	QTY/BUNDLE	PRICE	10+
WH640	64"	21	100	36.43	\$41.88

Wire Hoops

Heavy 3/16" Precut and Pre-arched High Tensile Steel



ITEM #	LENGTH	LBS	QTY/BUNDLE	PRICE	10+
WH64	64"	50	100	62.74	\$65.18
WH76	76"	60	100	69.49	\$72.25

2.5 oz/sq yard Thermal Blanket

A white non-woven needle punched polypropylene heavyweight blanket.



ITEM #	SIZE	PRICE
WFB06	6' x 250'	119.85
WFB12	12' x 250'	239.7
WFB15	15' x 250'	275.25

Woven Fabric to Anchor Row Cover

Sandbags are ideal for erosion control, or to weigh down the edges of row cover or anything you need to keep it from blowing around. Sandbags are made from woven fabric which resists tearing and puncturing. In addition, Sandbags are UV stabilized to last longer in direct sunlight.



ITEM #	SIZE	PRICE	100+
ACB1224	12" x 24"	0.47	\$0.40

Heavy Duty multi year anchor bag. With handles and built-in cinch tie. Extra strong and reusable.



ITEM #	SIZE	PRICE	10+
ACB1148	11" x 48"	1.65	\$1.19

Heavy Duty Sod Staples

Heavy duty staples to secure your ground cover or thermal blanket to the ground.



ITEM #	DESCRIPTION	PRICE	5+
SS610S	6" Sod Staples (per piece)	0.09	
SS88S	8" Sod Staples (per piece)	0.19	
SS88	8" Heavy Duty Sod Staples 500/cs	42.62	\$45.81
SS610	6" x 1", 11 Ga Sod Staples, 1000/box	37.93	\$40.25

Produce Containers and Bins

NEW ITEM!

New for 2025! These 5/8 bushel plastic crates can be nested in each other or half turn and stack on top of each other. Lighter and easier to clean than wood. UV treated for long life. 306 crates on a full pallet.



ITEM #	BUSHEL	DES	COL	PRICE	10+
PC058	5/8	Plastic Crate	Beige	8	\$8.13

Heavy Duty Baskets

U.V. stabilized polyethylene, FDA approved. Has ventilated bottom and sides, nests together for storage. Weight 1.2 lbs.



ITEM #	BUSHEL	WIDTH	DEPTH	PRICE	10+
PC05	1/2	14.5	12.25	6.99	\$8.13

U.V. stabilized polyethylene, FDA approved. Has ventilated bottom and sides, nests together for storage. Weight 1.8 lbs.



ITEM #	BUSHEL	WIDTH	DEPTH	PRICE	10+
PC06	5/8	15.5	13.25	8.41	\$9.17



ITEM #	DESCRIPTION	PRICE	10+
PC1259	White Handles for Orange Basket	3.97	
PC125	Orange All Purpose Basket (1.25 BU)	17.82	\$18.41
PC.5	Red All Purpose Basket (.5 BU)	9.85	\$9.55

Red Solid Basket

No holes.



ITEM #	DESCRIPTION	PRICE	10+
PC-065	5/8 Bu	\$9.82	\$9.33

Rectangular Lugs

7/8 bushel yellow berry lugs 23.6" long x 15.7" wide x 7" high

FDA approved high density polyethylene. Ventilated sides and bottom, (half turn) stack to nest design. Weight 3.25 lbs.



ITEM #	BUSHEL	WIDTH	DEPTH	PRICE	10+
PC07	7/8	23.3" x 15.7"	7"	16.19	\$18.32

BeriGard Berry Boxes



ITEM #	SIZE	QTY/CS	PRICE	10+	36+
BBB297	Quart	297	53.82	\$54.00	\$52.35
BBB420	Pint	420	48.5	\$48.60	\$47.11
BBB300	1/2	600	68.5	\$68.55	\$66.45

Keen Karrier

Here is a very handy metal carrying handle for handling 1/2 BU. or 3/8 BU. picking baskets or any other basket with a lip on the outside. It gives you the option of carrying 2 baskets of produce instead of one. It easily grabs and releases the basket for speed and efficiency.



ITEM #	PRICE
KEENKARR	37.28

Berry Containers

All of these produce carrying trays will nest and stack in each other regardless of the size of tray. They will nest then in a half a turn they will stack on top of each other with out crushing the fruit in the tray below. All of these are vented on the bottom and sides



Products Specifications:

- Constructed of High Density Polyethylene
- Stackable and Nestable
- Excellent U.V. Protection
- Food Grade
- Custom Color

ITEM #	LB	COLOR	WIDTH	DEPTH	PRICE	10+
PC15	15	Yellow	24" x 16"	5.25"	\$5.74	\$5.75
PC20	20	Blue	24" x 16"	5"	9.58	\$6.71
PC30	30	Green	24" x 16"	7"	10.21	\$8.43

1-1/8 bushel yellow berry lugs.

FDA approved high density polyethylene. Ventilated sides and bottom, (half turn) stack to nest design. Weight 4 lbs



ITEM #	BUSHEL	WIDTH	DEPTH	PRICE	10+
PC09	1 1/8	23.8" x 17.8"	7.7"	17.74	\$20.72

1.75 bushel green general purpose container. 23.5" long x 18.5" wide x 12.25" high.

UV stabilized. FDA approved polyethylene. Vent bottom and sides. Stack on top or nests in each other (half turn).



ITEM #	BUSHEL	WIDTH	DEPTH	PRICE	10+
PC175	1¾	23.5" x 18.5"	12.25"	20	\$20.45

Aluminum Berry Carriers

Holds 8-1 qt. boxes. Has twin carrying handles, that fold for easy storage.

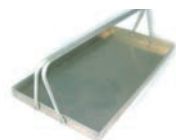

ITEM #	PRICE
ABC	37.11

Wooden Baskets



Hard Bottom

ITEM #	SIZE	PRICE	10+	50+
BHB10	Quarter Peck - 2 Quart	4.26	\$2.68	\$2.54
BHB15	Half Peck - 4 Quart	\$3.59	\$3.41	\$3.23
BHB25	One Peck - 8 Quart	5.24	\$4.78	\$4.53
BHB50	Half Bushel - 16 Quart	7.98	\$5.96	\$5.64

Harvest Ready Basket

Produce basket

- Ultra compact for stacking and nesting. 1" stacking height.
- Four handles for easy transfers from one person to the next.
- Handles integrated in the basket allow for tight stacking.
- Concave sides for comfortable carrying even when heavily loaded.
- Design allows for tight nesting reducing unused space.
- Super strong flexible polyethylene with max UV stability.
- One bushel fill line molded in basket.
- Height 15.5 Width 19.5 x 16.5



ITEM #	PRICE
RAIHR100	13.25

Wooden berry Flat



ITEM #	DESCRIPTION	SIZE	PRICE
WBC01	6 QT Wooden Berry Flat	8"L X 12"W X 3"H	4.95
WBC02	8 QT Wooden Berry Flat	23"L x 12"W x 6"H	6.89

Custom Crates

If you don't see the size or shape of a basket you want, we can custom make anything you want, just give us measurements and details.

PC 25 Shuttle Bin

Folding design reduces transport and storage cost. Available with optional (not standard) drop down door for easy access to produce at bottom of bin.



The ShuttleBin 330 is easy to set up, use for displays, knock-down, and return. Perfect for farm or farmers market retail display, with optional drop-down doors for easy access. Collapse to 12.1" high for empty return. Call for availability & Prices

ITEM #	DESCRIPTION	PRICE
PC25	OD 48" x 40" W 33"D	\$264.82

Wooden Crate

These crates all have a oak runner on the very bottom for more holding strength. The handle is the whole length of the side which makes it a lot easier to pass a full crate to another person and not trying to fit two hands in one handle.



ITEM #	PRICE	10+	108+
WBC025	1 Peck	4.21	\$3.79
WBC05	Half Bushel	6.32	\$5.48 \$5.19
WBC1	One Bushel	8.3	\$7.55 \$7.16
WBC058	1/2 Peck Wooden Crate	3.79	\$3.02

Mesh Produce Bag

These versatile mesh produce bags find uses around your farm and market. Harvest, transport, market, and store items like apples, onions, peppers, potatoes, and sweet corn. Sturdy mesh allows customers to see produce at market, while bags make transport and organization easy for you. Breathable mesh allows storage crops like onions, potatoes, and perennial bulbs to release excess moisture. Since bags hold up in water, they are ideal for soaking and rinsing harvested greens, peppers, or root crops. Each woven poly bag has a built-in draw cord that quickly closes the bag and acts as a handle for transport.



ITEM #	COLOR	SIZE	PRICE
MESBA1317	Red	13" x 17"	0.48
MESBA1525	White	15" x 25"	0.6
MESBA1832	Red	18" x 32"	0.67
MESBA2236	Green Corn	24" x 36"	0.89

Wooden Bin

A popular 20 bushel wooden bulk bin. Call for special sizes and styles. Ship weight 105 lbs.



ITEM #	SIZE	WIDTH	DEPTH	PRICE	10+
WBB20	20 Bushel	ID 44" x 39"	26"	75	\$75.52

Row Cover

This Row Cover protects against cold temperature, frost, wind, insects and birds including whitefly. Ideal for packing out earlier (or later-fall) quality produce. This unique non-woven fabric has remarkable tear resistance, and is U.V. stabilized. Allows majority of the light to reach the crops, which provides ideal day and night time cover protection. The 31', 36', 42', and 50' .56 oz. crop cover has reinforced edges.

- Light weight to gently protect young plants without crushing.
- Protects against light frost. Raises soil and air temperature by several degrees F.
- Earlier Planting.
- Earlier or Later harvests.
- Accelerated Growth & Higher Yields

PRO 19 - .56 oz

- 2-4 Degrees F Estimated Protection
- 85% Light Transmission

ITEM #	WEIGHT	SIZE	PRICE
COV19-1510	.56 oz	14.9' x 1000'	294.15
COV19-2610	.56 oz	26' x 1000'	503.56
COV19-3610	.56 oz	36' x 1000'	710.15
COV19-5010	.56 oz	50' x 1000'	\$981.02
COV19-710	.56 oz	7' x 1000'	122.69
COV19-725	.56 oz	7' x 250'	54.22

PRO 40 - 1.2 oz

- 7-8 Degrees F Estimated Protection
- 70% Light Transmission

ITEM #	WEIGHT	SIZE	PRICE
COV40-175	1.2 oz	17' x 500'	415.04
COV40-265	1.2 oz	26' x 500'	614.91
COV40-505	1.2 oz	50' x 500'	1190.53
COV40-710	1.2 oz	7' x 1000'	241.75
COV40-725	1.2 oz	7' x 250'	96.59



PRO 30 - .90 oz

- 4-6 Degrees F Estimated Protection
- 75% Light Transmission

ITEM #	WEIGHT	SIZE	PRICE
COV30-145	.90 oz	14.8' x 500'	237.8
COV30-265	.90 oz	26' x 500'	435.83
COV30-345	.90 oz	34.5' x 500'	579.4
COV30-505	.90 oz	50' x 500'	825.83
COV30-710	.90 oz	7' x 1000'	186.37
COV30-725	.90 oz	7' x 250'	70.7

Clear Perforated Multi-Row Cover

- Cost-effective low-temperature
- Excellent for tubers, brassicas, sweet corn, strawberries.
- Film is lightweight and can be placed directly on top of crop without supports.
- Easy removal, tractor assist possible.
- Generates a windbreak effect and physical barrier against bad weather such as hail.
- Multi-season usage possible.
- Can be used in conjunction with traditional frost blanket.
- Greenhouse effect under film to promote early harvest as well as for crop extension.
- Ground and air temperature increased 3.5-5.5 oF degrees during the day.
- High light transmission for increased photosynthesis compared to traditional covers.

ITEM #	LENGTH	LBS	MIL	PRICE	10+
CPC62	6' x 2000'	65	1.1	133.4	\$129.05
CPC33	33'x328'		1.6	189	\$129.05



Commercial Vegetable Seed for Mail Orders



Seeds

Seeds are sold only in the quantities or multiples of what is listed. Seeds are NOT returnable in any condition, except under a recall issued by the seed vendor due to germination or other issues concerning defective seeds.

Beans

VBL Snap Beans, Blue Lake 274, Green Bush

58 days • Plump, tender pods 5 to 6" long, with white seeds. Blue Lake 274 is an all-time favorite bean that's nearly fiber-free, produces prolifically over a long season and has excellent flavor, fresh or frozen. A heavy producer over a long season, it's excellent fresh or frozen. Plants yield early and need no support.



ITEM #	QTY/LB	PRICE
VBL-2	2 lb	\$3.93
VBL-5	5 lb	\$3.85
VBL-25	25 lb	\$3.73
VBL-50	50 lb	\$3.54

VST Strike

55 Days • Old Proven. 5"-6" smooth, straight slender pod. High yielding bean with good shipping. A great all around bean for all applications from auctions to roadside stands to homeowners. Great flavor fresh, canned, or frozen.



ITEM #	QTY/M	PRICE
VST-5	5 m	\$4.15
VST-10	10 m	\$3.74
VST-50	50 m	\$3.32

VBR Bronco

53 Days • 5.5" Pod Dark Green. Slender pods with a shiny darker color. High yield, fresh market.



ITEM #	QTY/M	PRICE
VBR-5	5 m	\$4.22
VBR-10	10 m	\$4.01
VBR-80	80 m	\$3.80

VGW Goldilocks Yellow Wax

54 days. High yields of quality good tasting, 6 in/15 cm slim, round, straight pods with a 4 sieve size. Vibrant shiny yellow pods with no green tips that set well off the ground.



ITEM #	QTY/M	PRICE
VGW-5	5 m	\$3.99
VGW-10	10 m	\$3.91
VGW-40	40 m	\$3.79

Lima - VF2 Fordhook 242

75 Days • Good under heavy weather conditions. 4" pods. The most popular and dependable lima bean. Outstanding yields of uniform pods even in adverse weather.



ITEM #	QTY/LB	PRICE
VF2	1 lb	4.7
VF2-5	5 lb	\$4.57
VF2-25	25 lb	\$4.06
VF2-50	50 lb	\$3.56

Beets

VRA Red Ace

53 Days • Deep red globe shape fresh market, smooth skin, heat resistant, high sugar content, fresh market.



ITEM #	QTY/M	PRICE
VRA-25	25 m	\$1.49
VRA-50	50 m	\$1.42
VRA-250	250 m	\$1.34

VDR Detroit Dark Red

58 Days • A long time favorite. The most popular beet sold. Globe shaped, uniform, smooth dark red with a small tap root.



ITEM #	QTY/LB	PRICE
VDR-.25	0.25 lb	\$8.29
VDR-.50	0.5 lb	\$8.13
VDR	1 lb	8.9
VDR-5	5 lb	\$7.57
VDR-50	50 lb	\$7.17

Broccoli

VGB Gypsy

74 days • Smooth dome heads with good holding ability, uniform.



ITEM #	QTY/M	PRICE
VGB-2.50	2.5 m	\$8.32
VGB-5	5 m	\$8.15
VGB-25	25 m	\$7.90
VGB-100	100 m	\$7.49

VIP Imperial

Warm harvest season which performs best under long day conditions with moderate heat and warm nights. Superior multi-use variety suitable for bunch, crown cut and processing.



ITEM #	QTY/M	PRICE
VIP-2.50	2.5 m	\$9.37
VIP-5	5 m	\$9.18
VIP-25	25 m	\$8.90
VIP-100	100 m	\$8.43

Cabbage

VB Bravo

85 Days • X large round head, nice color



ITEM #	QTY/M	PRICE
VB-2.50	2.5 m	\$6.99
VB-5	5 m	\$6.64
VB-25	25 m	\$6.29
VB-100	100 m	\$5.94

VTH Thunderhead

74 Days • Solid 3-5 lb head very compact dense head.



ITEM #	QTY/M	PRICE
VTH-2.50	2.5 m	\$9.32
VTH-5	5 m	\$8.85
VTH-25	25 m	\$8.39
VTH-100	100 m	\$7.92

VET Early Thunder

72 Days • 3-4 lb blue-green heads, slow bolting tolerance.



ITEM #	QTY/M	PRICE
VET-2.50	2.5 m	\$6.93
VET-5	5 m	\$6.58
VET-25	25 m	\$6.24
VET-100	100 m	\$5.89

Seeds are sold only in the package sizes listed below. Prices are per lb or per m

Cantaloupes (melons)

VAF Aphrodite

80 Days • 6-8lb Oval w-refined net, med. cavity orange flesh. Good disease resistance and remarkable flavor.



ITEM #	QTY/M	PRICE
VAF.50	.5 m	\$101.03
VAF	1 m	97.93
VAF-5	5 m	\$97.07
VAF-25	25 m	\$94.01

VAT Athena

80 Days • 5-7 lb Oval w/course net, small cavity, great shipper. Very good disease resistance and remarkable flavor.



ITEM #	QTY/M	PRICE
VAT.50	.5 m	\$103.41
VAT	1 m	102.8
VAT-5	5 m	\$99.35
VAT-25	25 m	\$96.31

VAM Astound

80 day Astound is an eastern shipper that features improved flesh firmness, a tighter seed cavity and an improved disease package for main to late season plantings. The oval fruit have a firm, orange flesh, weigh 6-8 lbs., a high quality appearance and improved shelf life. Astound's strong vine has resistance to powdery mildew (1,2) and Fusarium wilt (0,1,2), intermediate resistance to Cotton aphid and powdery mildew (3.5) and tolerance to sulfur burn.



ITEM #	QTY/M	PRICE
VAM.50	.5 m	\$95.02
VAM	1 m	100
VAM-5	5 m	\$91.30
VAM-15	15 m	\$88.50

Seeds

Carrots

VKSN - Scarlet Nantes

Orange-Red 6" roots. Very sweet carrot. A very popular carrot for fresh market. Available in 4 oz., 8 oz., and 1 lb.



ITEM #	QTY/LB	PRICE
VKSN-.25	4 oz	\$16.88
VKSN-.50	8 oz	\$16.55
VKSN	1 lb	18.98

VKN Nantindo

70 Day • Beautiful 6"-8" Roots with a deep orange color. Good carrot for market bunching. Excellent taste.



ITEM #	QTY/M	PRICE
VKN.50	.5 m	\$3.25
VKN	1 m	2.95

Cauliflower

VFL Flamenco Cauliflower

70 Days • High, white, domed heads. Strong plant with large leaves to shade from sun.



ITEM #	QTY/M	PRICE
VFL-2.50	2.5 m	\$44.93
VFL-5	5 m	\$42.68
VFL-25	25 m	\$40.44
VFL-100	100 m	\$38.19

VSE Steady Cauliflower

65 Days • 6"-7" domed, white heads. Performs well in Spring or Fall. Good inner wrap.



ITEM #	QTY/M	PRICE
VSE-2.50	2.5 m	\$21.85
VSE-5	5 m	\$20.76
VSE-25	25 m	\$19.67
VSE-100	100 m	\$18.57

Seeds are sold only in the package sizes listed below. Prices are per lb or per m

VSC Snow Crown

68 Days • 7" Med-large must be tied.



ITEM #	QTY/M	PRICE
VSC-2.50	2.5 m	\$15.98
VSC-5	5 m	\$15.66
VSC-25	25 m	\$15.18
VSC-100	100 m	\$14.38

Corn - Sweet Yellow

VBO Bodacious - Yellow, SE

75 Days • Early S.E. Hybrid with superior flavor and holding ability. 8" ear, good filling tip with exceptional eating quality.



ITEM #	QTY/LB	PRICE
VBO-2	2 lb	\$15.41
VBO-5	5 lb	\$15.10
VBO-25	25 lb	\$14.64
VBO-50	50 lb	\$13.87

VI Incredible Yellow SE

84 Days • 8.5" Ear Big flavorful ears, excellent appearance & yields. Good tip fill and husk cover with excellent flavor.



ITEM #	QTY/LB	PRICE
VI-2	2 lb	\$18.24
VI-5	5 lb	\$17.88
VI-25	25 lb	\$17.33
VI-50	50 lb	\$16.42

VHS Honey Select - Yellow, SE

79 Day- Long, elegant 8 inch ears are packed with remarkable crunchy-sweet kernels on this All-America Selection winner. One of an entirely new type of corn called TripleSweet, Honey Select hybrid combines the crunchy texture of sugary-enhanced types with the extra sweetness and great holding ability of the supersweets. The result? Delicious!



ITEM #	QTY/LB	PRICE
VHS-2	2.5 lb	\$19.15
VHS-5	5 lb	\$18.77
VHS-25	25 lb	\$18.19
VHS-50	50 lb	\$17.24

Corn - Sweet White

VA Argent White SE

86 Days • 8" Ear Stewart's wilt tolerant, white version of Incredible. Good husk protection. Vigorous in cool conditions. Tender, sweet kernels.



ITEM #	QTY/LB	PRICE
VA-2	2 LB	\$13.82
VA-5	5 LB	\$13.54
VA-25	25 LB	\$13.13
VA-50	50 LB	\$12.44

VAV Sweet Corn Avalon Triple Sweet

84 Days • 8" ear white, high sugar content



ITEM #	QTY/M	PRICE
VAV-5	5 m	\$10.07
VAV-10	10 m	\$9.87
VAV-50	50 m	\$9.57
VAV-100	100 m	\$9.06

Seeds are sold only in the package sizes listed below. Prices are per lb or per m

VLE Sweet Corn, Leadoff MXR - SH2

69 Days • Leadoff MXR is a Xtra Tender variety known for its excellent taste. Leadoff MXR is the first early hybrid with a high kernel row count and good kernel color. Leadoff MXR has a great disease package and very good husk protection. Leadoff the season right with this fresh market and roadside variety.



ITEM #	QTY/M	PRICE
VLE-5	5 m	\$12.25
VLE-10	10 m	\$12.01
VLE-50	50 m	\$11.76
VLE-100	100 m	\$11.52

Corn - Sweet Bi-color

VD Delectable Bicolor SE

82 Days • 9" Ear Great for a main season bicolor. Large well filled ears with a dark green husk. Exhibits a wide range of adaptability and versatility in several markets with wonderful tenderness and taste.



ITEM #	QTY/LB	PRICE
VD-2	2 lb	\$16.85
VD-5	5 lb	\$16.51
VD-25	25 lb	\$16.01
VD-50	50 lb	\$15.17

VKI Kickoff XR - Bicolor SH2

69 Days • Kickoff XR is a early augmented bicolor sweet corn. It offers excellent seedling vigor, superior eating quality and excellent ear size in the early slot. Bicolor kernels fill the 7.75-8" ears with 16-18 kernel rows. The ears are held at 28" off the ground on sturdy 6' plants and have tender, sweet kernels. Its attractive husk package offers ample flags and protects the ear well over the tip. Resistant to rust (Rp1-G). Isolation required.



ITEM #	QTY/M	PRICE
VKI-5	5 m	\$12.79
VKI-10	10 m	\$12.53
VKI-50	50 m	\$12.28
VKI-100	100 m	\$12.02

VTE Temptation Bicolor SE

72 Days • 7" Ear Sturdy plant, easy to snap. Good flavor. Good cold soil planting vigor, great husk cover and tip fill. High yield potential.



ITEM #	QTY/M	PRICE
VTE-5	5 m	\$9.86
VTE-10	10 m	\$9.66
VTE-50	50 m	\$9.47
VTE-100	100 m	\$9.27

VSK Silver King White SE

84 Days • 8" Ear Good disease resistance, attractive, high quality. Sweet flavor with nice crispness



ITEM #	QTY/M	PRICE
VSK-2	2 m	\$19.74
VSK-5	5 m	\$19.35
VSK-25	25 m	\$18.75
VSK-50	50 m	\$17.77

VMTK, Montauk, Bi-Color SH

79 Days • Montauk has become a grower favorite for its girthy, eye-appealing 8" ears, outstanding eating quality, and very high yield potential. Large, sweet ears.



ITEM #	QTY/M	PRICE
VMTK	1 m	11.67
VMTK-5	5 m	\$11.04
VMTK-10	10 m	\$10.82
VMTK-50	50 m	\$10.59

VP Providence Bicolor SYN

80 Days • 8" Ear Triple Sweet, rust resistant. Providence sweet corn has a superb eating quality that is suited for roadside and farm market sales.



ITEM #	QTY/M	PRICE
VP-5	5 m	\$9.41
VP-10	10 m	\$9.22
VP-50	50 m	\$8.94
VP-100	100 m	\$8.47

VXT Xtra Tender 274A SH2

71 Days • This Xtra-Tender bicolor sweet corn offers superb eating quality and tenderness. Very refined 8" ears are produced on sturdy plants with few tillers and have 18 to 20 rows of nicely contrasted yellow and white kernels. A dark green husk with long dark green flags covers the tender and sweet kernels well over the tip. An excellent sweet corn variety for roadside and local markets. Isolation required.



ITEM #	QTY/M	PRICE
VXT-5	5 m	\$12.89
VXT-10	10 m	\$12.63
VXT-50	50 m	\$12.37

Seeds are sold only in the package sizes listed below. Prices are per lb or per m

Corn - Ornamental

VF Fiesta

100 Days • 7"-10" Ear 50% purple husks multiple colors. Early maturing, full sized hybrid with attractive mixture of yellow, red, white, blue, purple and variegated kernels. Earlier and on shorter stalks than the standard Indian Ornamental.



ITEM #	QTY/LB	PRICE
VF-2	2 lb	\$14.71
VF-5	5 lb	\$13.97
VF-25	25 lb	\$13.24

VORH Ornamental Corn

Unique with a high percentage of red stalks and husks. Has a strong stalk 8-9 feet tall and stands well late in the season. Improvement to the standard Carousel.



ITEM #	QTY/LB	PRICE
VORH-.5	.5 lb	\$21.90
VORH	1 lb	20.84
VORH-5	5 lb	\$21.04

VIO Indian Ornamental

110 Days • 7"-9" Ear bright colored mix of kernels. Nice 8"-10" with a full range of glossy colors, 15-20% purple husks, strong plants.



ITEM #	QTY/LB	PRICE
VIO-2	2 lb	\$5.22
VIO-5	5 lb	\$4.96
VIO-25	25 lb	\$4.70
VIO-50	50 lb	\$4.44

Cucumber

VDA Dasher II

58 Days • Cucumbers are a proven favorite. Straight, classy, highly uniform, 8" dark green fruit are set on disease resistant vines. Yields and quality get high grades.



ITEM #	QTY/M	PRICE
VDA	1 m	13.99
VDA-5	5 m	\$12.28
VDA-15	15 m	\$11.64

VWA Stonewall

53 Days • Straight, dark green fruit. Resistant to Powdery Mildew



ITEM #	QTY/M	PRICE
VWA	1 m	15.94
VWA-5	5 m	\$14.23
VWA-15	15 m	\$13.48

VFE Feisty Pickling Cucumber

- Excellent fruit length
- Outstanding exterior quality
- Small seed cavity & slow seed development
- Good processing field
- Attractive green color



ITEM #	QTY/M	PRICE
VDA	1 m	13.99
VDA-5	5 m	\$12.28
VDA-15	15 m	\$11.64

Seeds are sold only in the package sizes listed below. Prices are per lb or per m

Eggplant

VEPS Santana

80 Days • Tall, Upright Plant w/heavy purple/black yields. TMV resistant. Oval Elongated fruit.

Fruit average 4" wide, 8.5" length.



ITEM #	QTY/M	PRICE
VEPS-.50	0.5 m	\$16.55
VEPS	1 m	17.84
VEPS-5	5 m	\$15.91
VEPS-25	15 m	\$15.42

Gourds

VAW Autumn Wings Med.

Mostly winged gourds. Avg Unique 3 in. winged swan/pear bulb with 6 in. neck



ITEM #	QTY/M	PRICE
VAW-.50	0.5 m	\$29.57
VAW	1 m	31.75
VAW-5	5 m	\$28.41
VAW-15	15 m	\$27.54

VSW Swan Gourds

The crooked neck widens at the tip to give it a swan's look. Fully matured huge 18 in long with 8 in base. Smooth dark green/mottled cream. Curved neck, swan head



ITEM #	QTY/LB	PRICE
VSW	1 oz	\$6.24
VSW-4	4 oz	\$5.93
VSW-16	16 oz	\$5.62

NEW VGS, Gourds, Galaxy of Stars, Warted and Winged.

95 days. An exciting and attractive hybrid gourd mixture, Galaxy of the Stars brings interest to your fall market displays. The mix produces unique star-shaped fruit in varying striped patterns in colors of yellow, cream, orange, green, and white. The mature fruit holds up well to mechanical washing and waxing. Galaxy of Stars gourds are an excellent variety to boost fall sales at roadside or farmer's markets.



ITEM #	QTY/M	PRICE
VGS		\$11.99
VGS		\$10.79

NEW VPG, Gourds, Princess Mix, Warted and Winged.

A warted blend of long necks and winged spoons. Highly improved color contrast over anything else on the market with darker greens and brighter whites that help the yellow, lime green and orange colors pop. Similar in size to Autumn Wings Medium.



ITEM #	QTY/M	PRICE
VPG		\$11.99

Kale

VTK, Tuscan Kale or (Lacinato Kale)

30-60 Days • This sweet, mild, blue-green, heavily crinkled strap leaves impart excellent flavor, especially harvested young and after first frost.



ITEM #	QTY/LB	PRICE
VTK-.25	.25 lb	\$22.74
VTK-.50	.5 lb	\$21.70
VTK	1 lb	13

VWK Winterbore Kale

60 days • One of the most winter hardy kales, Winterbore has finely curled, thick, blue-green leaves. Very vigorous, it can grow up to 2 feet, developing an abundance of ruffled, fancy leaves for salad mixes. A magnificent early spring and late fall kale, and great for market growers, too. Really sweet and juicy after frosts!



ITEM #	QTY/M	PRICE
VWK	1 m	12.67
VWK-5	5 m	\$10.79

Seeds are sold only in the package sizes listed below. Prices are per lb or per m

Lettuce

VLB, Buttercrunch

Cut lettuce • 65 Days • This extremely popular lettuce has a luscious, buttery texture. The soft heads are creamy yellow inside and have some heat resistance. Best in cooler regions.



Plant early in spring and repeat every 2 weeks into fall. Protect from heat with shade cloth. Likes fertile soil, ample water. Best when picked minutes before your meal.

ITEM #	QTY/LB	PRICE
VLB-.25	.25 lb	\$16.46
VLB-.50	.5 lb	\$16.30
VLB	1 lb	14.89

VGSS, Black Seeded Simpson

Cut lettuce • 45 Days • Hugely popular for over 150 years, it's one of the most tender and delicately flavored leaf lettuces ever bred. The ruffled leaves are large with an appealing green color. Simpson is well adapted to a wide range of climates and is still the best for early spring sowing.



ITEM #	QTY/LB	PRICE
VGSS-.25	.25 lb	\$14.56
VGSS-.50	.5 lb	\$14.28
VGSS	1 lb	13.91

VGI Green Ice

Cut lettuce • 45 Days • A customer Favorite! Green Ice is one of the sweetest cut lettuce. Gorgeous texture too. Large clusters of rich green, ruffled leaves.

ITEM #	QTY/LB	PRICE
VGI-.25	.25 lb	\$19.96
VGI-.50	.5 lb	\$19.57
VGI	1 lb	15.96

VLS, Summertime

75 Days • Produces firm heads with crisp texture and delicious sweet flavor. Quality is good even when temperatures are high. Proven tops for performance, flavor and wide adaptability.



ITEM #	QTY/LB	PRICE
VLS-.25	4 oz	\$99.23
VLS-.50	8 oz	\$97.32
VLS	1 lb	\$95.41

VLR, Red Salad Bowl

Red cut lettuce • 50 days • Red Salad Bowl is a long-standing, slow-to-bolt and early maturing lettuce that grows well all season and can be harvested over period of time. Its maroon-red, deeply cut and finely divided leaves are crisp and delicious and make an eye-catching addition mixed with green lettuce. Some tolerance to late-season mildew.



ITEM #	QTY/LB	PRICE
VLR-.25	.25 lb	\$22.69
VLR-.50	.5 lb	\$22.26
VLR	1 lb	22.97



Onions

All orders for Onion sets, Onion Plants, and seed potatoes must be picked up by May 1st 2024.



Onion Sets

Must be ordered in Dec. to Feb. (Packed in 1 bushel #32 bags) (Shipping Feb 1 to Mar 15) Shallots and Garlic available for special order only.

ITEM #	DESCRIPTION	QTY/LB	PRICE
OW32-1	White	1 lb	\$1.63
OW32	White	32 lb	\$32.97
OY32-1	Yellow	1 lb	\$1.63
OY32	Yellow	32 lb	\$32.97
OR32-1	Red	1 lb	\$1.63
OR32	Red	32 lb	\$32.97
OS01	Long Winter Keeper (Stuttgarter)	32 lb	\$32.97
OOW32	Oversize White	32 lb	\$25.28

Seeds are sold only in the package sizes listed below. Prices are per lb or per m

VCO Candy Onion

85 Days • A mild, sweet onion that will hold into winter if cured and stored in a cool dry place.



ITEM #	QTY/M	PRICE
VCO-50	.5 m	\$6.03
VCO	1 m	5.27
VCO-5	5 m	\$5.79
VCO-15	15 m	\$5.61

Transplant Onions

Candy Onion Plants

Onion sets already started from seed.



ITEM #	QTY	PRICE	60+
ONITRCAN	80-85 Plants/Bundle	\$3.11	\$2.64

Wala Wala Onion Plants

Onion sets already started from seed.



ITEM #	QTY	PRICE	60+
ONITRWAL	80-85 Plants/Bundle	\$3.11	\$2.64

Red Wing Onion Plants

Onion sets already started from seed.

ITEM #	QTY	PRICE	60+
ONITREDWI	80-85 Plants/Bundle	\$3.11	\$2.64



Garlic

Garlic Bulbs

30/LB, Approx. 10 bulbs/lb

ITEM #	QTY	PRICE
OG-35	30 lb - 10 Bulbs/lb	\$102.55

Garlic Bulbs

These large, plump bulbs have papery skins and plenty of creamy-white cloves bursting with excellent, spicy-hot flavor. Easy to grow, very productive, adaptable to any climate. Approx. 15-20 cloves per bulb



Peas

VDW Dwarf White

(Untreated available). 50 Days • 3" flat 30" vine, tender & sweet. Thin flat pods are 3" long, sweet, crisp and delicious.



ITEM #	QTY/LB	PRICE
VDW-2	2 lb	\$2.96
VDW-5	5 lb	\$2.15
VDW-25	25 lb	\$1.88
VDW-50	50 lb	\$1.61

VCC Cascadia

65 Days • 3" pod 24" vine, A snap pea with unusually thick-walled pods. Pods are at their peak at about 3" long, and have sweet, wrinkled little peas in them at that time. So crisp and juicy! The short, 32 inch vines yield an abundance of dark green 3 1/2 inch pods that are thick, juicy, and very sweet.



ITEM #	QTY/LB	PRICE
VCC-2	2 lb	\$2.95
VCC-5	5 lb	\$2.89
VCC-25	25 lb	\$2.80
VCC-50	50 lb	\$2.66

Seeds are sold only in the package sizes listed below. Prices are per lb or per m

VDG Dwarf Grey

65 Days • This edible pod snow pea has beautiful purple bi-colored flowers. The 2-3" flat pods are pale green, sweet, crisp, and fiber-free. Can also be grown for pea shoots, a delicious delicacy.



ITEM #	QTY/LB	PRICE
VDG	1 lb	2.49
VDG-2	2 lb	\$1.78
VDG-5	5 lb	\$1.68

VOS Oregon Sugar Pod II

38" vine, disease resistant. 4"x3/4" Pods, Snow pea with mild, sweet flavor. Smooth pod. High yielding. Can also be grown for pea shoots, a delicious delicacy.



ITEM #	QTY/LB	PRICE
VOS-2	2 lb	\$2.70
VOS-5	5 lb	\$2.43
VOS-25	25 lb	\$2.16
VOS-50	50 lb	\$1.89

VS Sugar Sprint

Snap Peas produces excellent early yields of edible, stringless pods that are very sweet and tender. The 3 in. pods can be enjoyed fresh off the vine, steamed or used in stir-fry.



ITEM #	QTY/LB	PRICE
VS-2	2 lb	\$6.84
VS-5	5 lb	\$6.50
VS-25	25 lb	\$6.16
VS-50	50 lb	\$5.47

VES Hull Peas, Spring

57 Days • 3" blunt pod, 22" vine, compact and early. This is a very early pea that bears large crops on medium sized plants. Pods hold 6 to 7 plump peas, vines grow 20" tall.



ITEM #	QTY/LB	PRICE
VES-2	2 lb	\$2.82
VES-5	5 lb	\$2.54
VES-25	25 lb	\$2.26
VES-50	50 lb	\$1.97

VPEN Hull Peas, Penelope Pea

50 days. This 34" tall pea has high resistance to pea enation mosaic virus and is an excellent choice for home gardens or farmers markets. This local favorite is one of our top recommended varieties of hull peas. Productive plants produce extra long, fancy pods that are easy to shell and most contain 8 to 9 delicious sweet peas. Can be grown with or without support.



ITEM #	QTY/LB	PRICE
VS-2	2 lb	\$6.84
VS-5	5 lb	\$6.50
VS-25	25 lb	\$6.16
VS-50	50 lb	\$5.47

VGA Green Arrow

68 Days • 4.5" pods large yields, bright green color. Heavy yields later. This very heavy yielder bears slim, straight pods packed with 9-11 small, deep green berries. Exquisite flavor and tenderness makes Green Arrow suitable for fresh market or freezing.



ITEM #	QTY/LB	PRICE
VGA-2	2 lb	\$2.14
VGA-5	5 lb	\$1.93
VGA-25	25 lb	\$1.71
VGA-50	50 lb	\$1.50

Seeds are sold only in the package sizes listed below. Prices are per lb or per m

Peppers

VKA King Arthur

67 Days • 4.5" x 4.5" fruit, upright & strong plant, sets well in heat. The large, blocky peppers are sweet, thick-walled, and ripen from green to bright red. The upright, multi-virus resistant plant sets well in heat and provides excellent cover for its heavy yields.



ITEM #	QTY/M	PRICE
VKA-.50	.5 m	\$65.56
VKA	1 m	64.21
VKA-5	5 m	\$62.98
VKA-25	25 m	\$61.06

VRK Red Knight X3R

64 Days • 4.5" x 4" fruit compact sturdy plant, heavy yields. The shiny, attractive fruit ripen from a dark green to an intense red color.

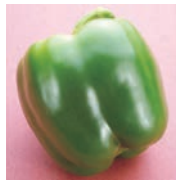

ITEM #	QTY/M	PRICE
VRK-.50	.5 m	\$87.11
VRK	1 m	80.2
VRK-5	5 m	\$82.08
VRK-25	25 m	\$79.57

VRV Revolution

72 Days • 5" x 5" fruit. Large plant, great disease resistance.



ITEM #	QTY/M	PRICE
VRV-.50	.5 m	\$92.97
VRV	1 m	90.76
VRV-5	5 m	\$89.33
VRV-15	15 m	\$86.59

VMYP Peppers, Mecate (Green to Yellow)

75 Days • Uniform, smooth, medium to large blocky fruit, matures green to yellow and does not turn orange. Tolerant to BLS 1,2,3; TMV; PMMoV 1,2 and PepMoV



ITEM #	QTY/M	PRICE
VMYP-.50	.5 m	\$74.47
VMYP	1 m	70.97
VMYP-5	5 m	\$71.51
VMYP-15	15 m	\$69.32

Potatoes

Seed Potatoes available in March & April. 50lb Bags (Totes also available).

List of potatoes that we can provide that are not listed; Adirondack Red, Adirondack Blue, Chieftain Potatoes (Red), Katahdin Potatoes (White), Russet Potatoes (White), Magic Molly Purple Potatoes, Red Thumb Fingerling Potato, Russian Banana Fingerling Potato (Yellow), Cobbler Potato Seed (White), Norwis Russet Potato (White)

All orders for Onion sets, Onion Plants, and seed potatoes must be picked up by May 1st 2025



Yukon Gold

Mid-to-late season • Yukon Gold is a large variety of potato most distinctly characterized by its thin, smooth eye free skin and yellow tinged flesh. Unlike some other potato the Yukon Gold can stand up to both dry heat and wet heat cooking methods. Its waxy moist flesh and sweet flavor make it ideal for boiling, baking and frying but these potatoes will also withstand grilling, pan frying, and roasting.

Reba

Mid-to-late season • Excellent flavor--one of the highest rated in taste-tests Good for baking (not too dry, not too moist), potato salads, boiling, mashing, chipping. Bright white flesh. Shape: Round to oval to oblong. Skin: Smooth, bright white to buff colored.

Seeds are sold only in the package sizes listed below. Prices are per lb or per m

Yukon Gold

Mid-to-late season • Yukon Gold is a large variety of potato most distinctly characterized by its thin, smooth eye free skin and yellow tinged flesh. Unlike some other potato the Yukon Gold can stand up to both dry heat and wet heat cooking methods. Its waxy moist flesh and sweet flavor make it ideal for boiling, baking and frying but these potatoes will also withstand grilling, pan frying, and roasting.

Reba

Mid-to-late season • Excellent flavor--one of the highest rated in taste-tests Good for baking (not too dry, not too moist), potato salads, boiling, mashing, chipping. Bright white flesh. Shape: Round to oval to oblong. Skin: Smooth, bright white to buff colored.

Kennebec

Mid-to-late season • A popular all-purpose potato with smooth skin and texture, and white flesh that resists late blight and yields heavily at midseason. The Kennebec potato is a high-yielding, fast growing, widely adapted and vigorous potato variety with excellent storage qualities. Not only is it sold as a fresh market potato, it is widely distributed for processing as frozen fries and potato chips.

Eva

Mid season • Bright white skin and white flesh with texture a little mealy lend these tubers to mashing, baking, and home-made chips! Excellent storage. Resistant to golden nematode, common scab, viruses, early blight and hollow heart. Does everything well in the kitchen and has good flavor.

Lehigh

Late season • A great all-purpose potato: good for baking, mashing, boiling, frying, home-fries and they make a mean potato salad. Potato growers found that Lehigh offered consistently high yields across very diverse growing regions. These round to oblong, slightly flattened tubers with appealing yellow flesh provide good flavor. Resistant to blackspot bruise; tolerant to scab.

Red Norland

Early-midseason • Selected for richer red skin color. Round to oblong tubers have white flesh, store well, and are excellent for boiling. The "Red Norland" potato is great for cooking, very healthy and easy to grow! Very good for boiling and salads. Good for frying, roasting, and French frying. This is an outstanding red potato that offers both great flavor and heavy yields.

Red Pontiac

A mid-season variety • Offers sweet, solid white flesh with a flavor you just have to try to believe! The large, round tubers hold their shape and color during cooking, making them a great all-around choice for boiling, baking, frying, and mashing. If you just can't wait until harvest time for a potato fix, pluck these new red potatoes earlier for a simple, tasty treat - boiled, lightly seasoned, and straight to your plate!

Superior,

White, Superior is a widely-grown, popular variety. Early maturing, moderately-high yields, and minimal skinning enables growers to dig and market quickly. Round to oblong tubers with buff, slightly flaky skin and white flesh are suitable for many uses. Good resistance to internal defects and common scab. Reliable and early, Superior is always one of the first varieties Excellent for chipping, but suitable for all cooking styles.

All of these potato varieties are available in Size B as well. Size A's are 1.5"-3.25" and they usually require cutting. Size B's are 1.5"-2" and usually are planted whole.

(Totes with 2,000 lb Seed Potatoes Available, call for pricing.)

ITEM #		COLOR	PRICE	20+	40+
POTYUK	Yukon Gold	Yellow	\$25.00	\$24.50	\$23.75
POTREB	Reba	White	\$25.00	\$24.50	\$23.75
POTKEN	Kennebec	White	\$26.00	\$25.48	\$24.70
POTEVA	Eva	White	\$25.00	\$24.50	\$23.75
POTLEH	Lehigh	Yellow	\$25.00	\$24.50	\$23.75
POTNOR	Dark Red Norland	Red	\$25.00	\$24.50	\$23.75
POTPON	Red Pontiac	Red	\$25.00	\$24.50	\$23.75
POTSUP	Superior	White	\$25.00	\$24.50	\$23.75

Seeds are sold only in the package sizes listed below. Prices are per lb or per m

Jack-O-Lantern Pumpkins

VCA Cannon Ball

110 Days • 5 lbs Dark orange, slight ribs



ITEM #	QTY/M	PRICE
VCA-.50	.5 m	\$90.89
VCA	1 m	86.98
VCA-5	5 m	\$87.33
VCA-15	15 m	\$84.65

VFT Field Trip

110 Days • 4-5lbs. Flat globe shaped fruit PMT



ITEM #	QTY/M	PRICE
VFT-.50	.5 m	\$104.18
VFT	1 m	105.74
VFT-5	5 m	\$100.10
VFT-15	15 m	\$97.03

VGMF Gold Medal

95 Days • 35-40 lbs, dark green handle, uniform, large. Very attractive size, color and shape for the retail market. Uniform, exceptional handles and a great yielder.



ITEM #	QTY/M	PRICE
VGMF-.50	.5 m	\$61.00
VGMF	1 m	71.72
VGMF-5	5 m	\$59.49
VGMF-15	15 m	\$59.49

VM Jack Be Little

100 Days • 3" x 4" bright orange

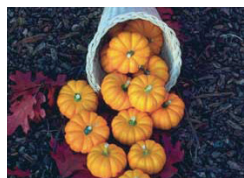

ITEM #	QTY/M	PRICE
VM-.50	0.5 m	\$45.97
VM	1 m	46.75
VM-5	5 m	\$44.17

VAP Pumpkin Apprentice

115 Days • 1-2lbs Apprentice is a smaller version of our popular Lil' Ironsides. Compact bush plants produce good yields of 1 lb. hard shell pumpkins.



The round fruit are 4 to 5" in diameter, smooth with no ribbing, and have an eye-appealing burnt orange color. The handles are well proportioned to the fruit, and the fruit has intermediate resistance to Phytophthora and Fusarium fruit rots. These are fantastic items for decorating and painting as they have a long shelf life.

ITEM #	QTY/M	PRICE
VAP-.50	.5 m	\$106.31
VAP	1 m	109.64

VKRF Pumpkin Kratos

100 Days • Strong, powerful, large pumpkin. 14" fruit height. Good yield, grower friendly. Large, flat-round, medium ribbed fruit. 25-30 lb average



ITEM #	QTY/M	PRICE
VKRF-.50	.5 m	\$124.49
VKRF	1 m	124.95
VKRF-5	5 m	\$188.27

VLP Lil' Pum-ke-mon

100 Days • 1-2 lbs White w/orange & green stripes



ITEM #	QTY/M	PRICE
VLP-.50	0.5 m	\$100.36
VLP	1 m	108.73
VLP-5	5 m	\$96.42

Seeds are sold only in the package sizes listed below. Prices are per lb or per m

VMT Mystic Plus

110 Days • 5-10 lbs 7" x 9" (HxW) PMT



ITEM #	QTY/M	PRICE
VMT-.50	0.5 m	\$90.78
VMT	1 m	92.04
VMT-5	5 m	\$87.22
VMT-15	15 m	\$84.55

VMW Magic Wand

115 Days • Improved Magic Lantern w/ better stem and double disease resistance, PMT, 15-25 lb.



ITEM #	QTY/M	PRICE
VMW-.50	0.5 m	\$111.67
VMW	1 m	103.99
VMW-5	5 m	\$107.29
VMW-25	25 m	\$105.10

VPW Prizewinner

120 Day • 100+ lbs. Red/orange, shallow ribs, exhibition pumpkin. With a fairly uniform shape for a big pumpkin and a consistent, bright reddish-orange color, Prizewinner is an excellent contest pumpkin. Its typical pumpkin shape with shallow ribs makes it a good fit for roadside displays, too.



ITEM #	QTY/M	PRICE
VPW-.05	0.05 m	\$596.78
VPW-.25	0.25 m	\$564.23
VPW-3	3 m	\$542.53

VRH Rhea Pumpkin,

110 Days • A new 20-30 lb, dark orange pumpkin with dark and firmly attached handle, very well ribbed pumpkin, perfect for roadside stands and pick your own.



ITEM #	QTY/M	PRICE
VRH-.50	0.5 m	\$120.45
VRH	1 m	114.56
VRH-5	5 m	\$115.73
VRH-25	25 m	\$112.19

V98 Cronus Pumpkin

115 Days • Destined to become one of the most widely used pumpkin varieties. 25-60 lb. fruit, very attractive, rich dark orange, well defined ribs, consistent blocky/round shape.



ITEM #	QTY/M	PRICE
V98-.50	0.5 m	\$122.16
V98	1 m	123.4
V98-5	5 m	\$117.36
V98-15	15 m	\$113.77

V89 Gladiator

110 Days • 20-30 lbs. Dark orange distinct rib PMT



ITEM #	QTY/M	PRICE
V89-.50	0.5 m	\$112.44
V89	1 m	108.32
V89-5	5 m	\$108.04
V89-15	15 m	\$104.73

Seeds are sold only in the package sizes listed below. Prices are per lb or per m

V83 Magic Lantern

110 Days • 15-25 lbs. Dark orange, med ribs PMT



ITEM #	QTY/M	PRICE
V83-.50	0.5 m	\$87.17
V83	1 m	\$85.46
V83-5	5 m	\$83.75
V83-15	15 m	\$81.19

VWG, Warty Goblin

105 Days • Warty Goblin pumpkin seed produces heavily warted pumpkins that are frighteningly cool! Have orange hard shell rind with green warts that stay green for several weeks after harvest. 8-20 lb.



ITEM #	QTY/M	PRICE
VWG-.50	0.5 m	\$135.72
VWG	1 m	133.76
VWG-5	5 m	\$130.40
VWG-15	15 m	\$126.41

V96 Apollo

115 Days • 22-30 Uniform with large handles, PMT



ITEM #	QTY/M	PRICE
V96-.50	0.5 m	\$121.36
V96	1 m	118.98
V96-5	5 m	\$116.60
V96-15	15 m	\$113.03

VZUF Zeus Pumpkin

110 Days • 16-20 lbs. Dark orange w/ large dark green handles. Med ribs, resistant to powdery mildew.



ITEM #	QTY/M	PRICE
VZUF-.50	0.5 m	\$115.44
VZUF	1 m	122.32
VZUF-5	5 m	\$110.92
VZUF-15	15 m	\$107.52

Stacker Pumpkins

VFY Fairytale

125 Day • 20-30 lbs. 8" x 13". Very deep ribs, mottled flat.



ITEM #	QTY/M	PRICE
VFY-.50	0.5 m	\$74.69
VFY	1 m	72.96
VFY-5	5 m	\$71.77
VFY-15	15 m	\$69.57

VPBD Blue Doll Pumpkin

100 days Blue Doll pumpkin has an exotic blue color to its blocky, deeply ribbed fruit. Large vines produce excellent yields of 20-24 lb. fruit that have a blue colored rind and sweet, deep orange flesh. Blue Doll's flesh is good for pies, soups or canning. Intermediate resistance to Powdery Mildew.



ITEM #	QTY/M	PRICE
VPBD-.50	0.5 m	\$11.73
VPBD	1 m	138.59
VPBD-5	5 m	\$107.35
VPBD-15	15 m	\$104.06

VWFBF White Flat Boer Ford Pumpkin

105 days Flat White Boer Ford pumpkin offers a unique shape for specialty markets and fall displays. Vigorous vines produce 10-15 lb. fruit that are flat in shape and scalloped. The fruit have a good white color and the color does not bleach out or yellow over time. White Flat Boer Ford pumpkin has bright orange flesh that has a sweet taste. Stores well for winter sales.



ITEM #	QTY/M	PRICE
VWFBF-.50	0.5 m	\$54.37
VWFBF	1 m	64.72
VWFBF-5	5 m	\$52.23
VWFBF-15	15 m	\$50.64

VPJ Jarradale Pumpkin

100 days. Slate, blue-grey, 7-8 lb pumpkins of superb quality. Their shape is flat, ribbed, and very decorative; also a good keeper. An excellent variety. One of the more tasty varieties for many savory dishes and is excellent for a year-round supply of squash, as these will often keep well over 12 months!



ITEM #	QTY/M	PRICE
VPJ-.50	0.5 m	\$39.72
VPJ	1 m	39.06
VPJ-5	5 m	\$38.16
VPJ-15	15 m	\$36.99

Seeds are sold only in the package sizes listed below. Prices are per lb or per m

VPD Porcelain Doll Pumpkin

110 days The perfect pink partner to Jarrahdale. Add diversity to fall ornamental displays with the unique color of Porcelain Doll. The sweet flesh can be used for pies, soups, and other gourmet delights. Full vines bear blocky, deeply ribbed fruit averaging 20-24 lb. NOTE: Wait to harvest until fruits turn fully pink and handles are "corky" in appearance. Intermediate resistance to powdery mildew.



ITEM #	QTY/M	PRICE
VPD-.50	0.5 m	\$164.78
VPD	1 m	170.92
VPD-5	5 m	\$158.32
VPD-15	15 m	\$153.47

VCP Cinderella Pumpkin

15-25 lb 110 day. This classic Heirloom Pumpkin is as traditional as they come! With its lovely, smooth orange skin and flattened "old fashioned" shape, this pumpkin is just as suited to be decoration as it is to be a delicious pie!



ITEM #	QTY/M	PRICE
VCP-.50	0.5 m	\$68.96
VCP	1 m	67.61
VCP-5	5 m	\$66.26
VCP-15	15 m	\$64.23

White Pumpkins

VWCC Cotton Candy White

Cotton Candy is the most attractive white pumpkin we have due to its true, white color. It has a smooth, slightly ridged skin that is actually white. The handles are dark green attached, which is unusual for a white pumpkin. Store in a dark place to maintain the true white color. Excellent yields. 5-12 lb.



ITEM #	QTY/OZ	PRICE
VWCC-2	2 oz	\$51.38
VWCC-4	4 oz	\$50.39
VWCC-8	8 oz	\$49.40

VPB Polar Bear

110 Days • 30-40 lbs (white) Retains its color after maturity in the field, at the market, and in decorative displays. Long, vigorous vines produce extra large 30-40 pound, true white pumpkins.



ITEM #	QTY/M	PRICE
VPB-.25	0.25 m	\$170.89
VPB-.50	0.5 m	\$169.22
VPB	1 m	167.37

Radish

VCH Champion

21 Days • Bright red glove shape, very firm, slow to pithy. Strong tops for upland soils. Good for bunching and shipping



ITEM #	QTY/M	PRICE
VCH-.25	0.25 lb	\$6.79
VCH-.50	0.5 lb	\$6.66
VCH	1 lb	6.93
VCH-5	5 lb	\$6.40

VCHSUB Early Scarlet Globe

One of the most popular home garden varieties of the past 100 years. Early, high-yielding, this heirloom radish favorite produces uniform, bright red globes with crisp, tender, juicy and mild white flesh.



ITEM #	QTY/M	PRICE
VCHSUB-.25	0.25 lb	\$7.83
VCHSUB-.50	0.5 lb	\$7.68
VCHSUB	1 lb	7.94
VCHSUB-5	5 lb	\$7.38

Seeds are sold only in the package sizes listed below. Prices are per lb or per m

Spinach

VWB Winter Bloomsdale

45 Days • Adapted for late summer/early fall plantings and overwintering. Slow bolting plants. Dark green, well-savoyed leaves.



ITEM #	QTY/M	PRICE
VWB-.50	0.5 lb	\$13.62
VWB	1 lb	10.23
VWB-5	5 lb	\$11.14
VWB-25	25 lb	\$9.90

VSV2157, Spinach, SV2157 - Hybrid

Shines all summer long. Has excellent thickness, uniformity and field holding ability. With very dark glossy leaves and good yield potential this is an attractive variety that adapts very well to a summer production. Growers will appreciate this strong plant with high resistance to Downy mildew races 1-13, 15 and 16.



ITEM #	QTY/M	PRICE
VSKOOK-25	25 m	\$1.11
VSKOOK-50	50 m	\$1.00
VSKOOK-250	250 m	\$0.89

Tomatoes

VMFP Mountain Fresh

78 Days • Determinate vines offer cover and produce extra-large fruit. The firm, smooth fruit with clean shoulders, and excellent uniform red color. Resistant to Nematodes, V1, F1 and F2.



ITEM #	QTY/M	PRICE
VMFP-.50	0.5 m	\$69.47
VMFP	1 m	68.34
VMFP-5	5 m	\$66.75

VPR Primo Red

68 Days • Cold tolerant, for fall and over wintering.



ITEM #	QTY/M	PRICE
VPR-.50	0.5 m	\$108.34
VPR	1 m	106.25
VPR-5	5 m	\$104.10

VDU Red Deuce

72 Days • Fresh market, determinate, round, second early vine ripe with exceptional fruit quality.



ITEM #	QTY/M	PRICE
VDU-.50	0.5 m	\$103.95
VDU	1 m	105.88
VDU-5	5 m	\$99.87

VPE Pony Express

72 Days • A perfect combination of earliness and high yield. Very concentrated, heavy yield fruit. Widely adaptable.



ITEM #	QTY/M	PRICE
VPE-.50	0.5 m	\$82.52
VPE	1 m	83.72
VPE-5	5 m	\$79.28
VPE-25	25 m	\$76.86

VRD Scarlet Red

75 Days • 11oz. Oblate, if you are looking for a firm shipping tomato with a great color and tops in taste tests then you've found it. Smooth, fancy fruit.



ITEM #	QTY/M	PRICE
VRD-.25	0.25 m	\$103.01
VRD-.50	0.5 m	\$101.03
VRD	1 m	101.31
VRD-5	5 m	\$97.07

VSM Smarty

69 Days • 7oz. Indeterminate. Good taste, short internodes.



ITEM #	QTY/M	PRICE
VSM-.25	0.25 m	\$197.50
VSM-.50	0.5 m	\$193.70
VSM	1 m	\$189.90
VSM-5	5 m	\$186.10

Seeds are sold only in the package sizes listed below. Prices are per lb or per m

Turnips

VPT Purple Top White Globe

58 Days • A true turnip for early summer harvesting. Produces round roots about 4 in. diameter, purple shoulder, white body. Tops suitable for "greens".



ITEM #	QTY/LB	PRICE
VPT-.50	0.5 lb	\$4.04
VPT	1 lb	3.9
VPT-5	5 lb	\$3.47
VPT-25	25 lb	\$3.08

Watermelon - Diploid

VCS Crimson Sweet

88 Days • 15-25 lbs. A good-sized (15-25 lbs.) nearly round fruit with about equal amounts of dark and light green striping. The orange-red flesh is crisp, has excellent flavor and small brown seeds. Crimson Sweet is a full-season beauty for local markets and shipping.



ITEM #	QTY/LB	PRICE
VCS	1 oz	3.75
VCS-4	4 oz	\$2.44
VCS-8	8 oz	\$2.09
VCS-16	16 oz	\$1.75

VSA Sangrai

87 Days • 22-26Lbs elongated, bright dark flesh, local market. Very sweet flesh with excellent quality. Abundant yields. Widely adapted.

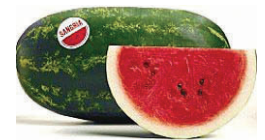

ITEM #	QTY/M	PRICE
VSA-.25	.25 m	\$109.29
VSA-.50	.5 m	\$107.19
VSA	1 m	124.46

VYB Yellow Baby

65 Days • Globe shaped 6 lb. personal size melon with tender, juicy 11-12% brix flesh.



ITEM #	QTY/M	PRICE
VYB-.25	.25 m	\$89.46
VYB-.50	.5 m	\$85.40
VYB	1 m	\$81.33

Watermelon - Triploid

Seedless watermelons require special conditions to germinate. They may not field germinate and it is recommended to get an experienced grower to start them. Potting soil must be light and coarse and temperature 90 degrees. Water and heat soil before planting, and seed 1" deep. Do not water again until they emerge, 2-4 days max. Then keep heat stable at 70" until planting.

VACP Accomplice

Accomplice pollinator has intermediate resistance to Fusarium wilt (races 0 and 1), it also offers resistance to Anthracnose (race 1). Its small vine, which does not compete with seedless watermelon varieties, is a prolific producer of male flowers throughout the entire crop cycle. As with Side Kick watermelons, plant one Accomplice between each third and fourth plant for optimum pollination. Also, the fruit produced by Accomplice are small and easily distinguishable from all seedless watermelon varieties.

ITEM #	QTY/M	PRICE
VASP		\$0.00



Seeds are sold only in the package sizes listed below. Prices are per lb or per m

VGGW Red Garnet Hybrid Triploid

Red Garnet has consistently shown outstanding seeding vigor in the greenhouse producing stout transplants and in field providing a strong aggressive vine that provides excellent fruit coverage and sun protection. Red Garnet is a dark green stripe type seedless watermelon showing wide adaptability in commercial fields throughout most North American production areas. The strong vigorous plant produces uniform 16-20 lbs. of oval fruit with deep red flesh in about 84 days.



ITEM #	QTY/LB	PRICE
VGGW-.25	0.25 lb	\$307.02
VGGW-.50	.50 lb	\$304.01
VGGW-1	1 lb	\$301.00

VBC Buttercup - Yellow Triploid

90 Days • 14-16 lbs. Nearly round fruit w/flavorful bright yellow fruit. Flesh is dense, crisp and high in sugars.

Recommended pollinator is Side Kick.



ITEM #	QTY/M	PRICE
VBC-.25	.25 m	\$375.19
VBC-.50	.5 m	\$364.47
VBC	1 m	\$357.32
VBC-5	5 m	\$350.17

VFW Fascination

80 days Fascination produces excellent quality 16-20 lb. fruit that have a glossy and rich looking dark green striped rind pattern. The firm flesh is deep red, contains very small pips and has a great watermelon flavor. Fascination makes a great shipping melon and holds well after harvest. Intermediate resistance to Fusarium wilt (race 1) and Anthracnose (race 1).



ITEM #	QTY/M	PRICE
VFW-.25	.25 m	\$401.39
VFW-.50	.5 m	\$397.46
VFW	1 m	397.09

VMI Millionaire

82 Day • 18-22 lbs. Round, deep pink flesh, strong rind.



ITEM #	QTY/M	PRICE
VMI-.25	.25 m	\$300.82
VMI-.50	.5 m	\$297.87
VMI	1 m	294.49
VMI-5	5 m	\$289.02

VRE Revolution Watermelon

80 Days • 20-26 lbs. Unique for size, shape and rind pattern. High sugar content. Finely textured flesh.



ITEM #	QTY/M	PRICE
VRE-.25	.25 m	\$359.37
VRE-.50	.5 m	\$355.84

Zucchini & Squash

VCG Cougar Summer Squash

50 Days • Yellow straight neck, virus tolerant.



ITEM #	QTY/M	PRICE
VCG-.25	.25 m	\$75.08
VCG	1 m	79.23
VCG-5	5 m	\$72.14
VCG-15	15 m	\$69.93

VGL Golden Glory

47 Days • Deep yellow 7-8" zucchini. Open, upright plant with few spines. Easy to harvest for fresh market.



ITEM #	QTY/M	PRICE
VGL-.25	.25 m	\$81.11
VGL	1 m	80.49
VGL-3	3 m	\$77.93
VGL-15	15 m	\$75.54

Seeds are sold only in the package sizes listed below. Prices are per lb or per m

VNP Neck Pumpkin

120 Days • 18-24" long w/4-5" neck and a 9" bulb. This squash variety is actually a relative of butternut types but with a very long neck that's packed with sweet tasting orange flesh.



ITEM #	QTY/LB	PRICE
VNP-.50	.5 lb	\$35.46
VNP	1 lb	\$34.10
VNP-5	5 lb	\$33.42

VSY Spineless Beauty

50 Days • This popular hybrid squash has no spines on its petioles, making it easier to pick and causing less damage to the fruit when harvested. A late season variety producing big yields of uniform, medium green fruit continuously throughout the season.



ITEM #	QTY/M	PRICE
VSY-.25	.25 m	\$44.39
VSY	1 m	73.58
VSY-3	3 m	\$39.54
VSY-15	15 m	\$38.74

VVS Winter Squash

110 days This unusual winter squash produces spaghetti-like strands of flesh, which add interesting variety to your fall and winter offering. The oblong fruit are 8 to 10 long and turn yellow when ripe. Vegetable Spaghetti is a good keeper and can be stored for several months. Try it for something a little different this year.



ITEM #	QTY/LB	PRICE
VVS-.50	.5 lb	\$122.42
VVS	1 lb	75.71
VVS-5	5 lb	\$78.70

VRW Reward

45 Days • A new replacement for Wildcat with a more open bush. Glossy, early high yields, straight & long fruit.



ITEM #	QTY/M	PRICE
VRW-.25	.25 m	\$86.52
VRW	1 m	85.52
VRW-3	3 m	\$83.12
VRW-15	15 m	\$80.58

VTA Royal Ace Acorn

72 Days • Dark green outside, bright orange flesh



ITEM #	QTY/M	PRICE
VTA-.50	.5 m	\$49.43
VTA	1 m	46.88
VTA-3	3 m	\$47.49
VTA-15	15 m	\$46.04

VWH Waltham Butternut

100 Days • Creamy straight fruit. Fruit are 8-10 in. long with thick, cylindrical necks. Its flesh color is rich and stores well, late into winter. Yielding heavily, it shows remarkable uniformity and is virtually free of slim or crooked necks. Its rind is creamy tan and slightly ridged.



ITEM #	QTY/LB	PRICE
VWH-.25	.25 lb	\$25.97
VWH-.50	.5 lb	\$20.78
VWH	1 lb	14
VWH-5	5 lb	\$13.36

A note from us:

If you order any watermelon seeds you're automatically agreeing to the following terms: Bacterial fruit blotch (BFB) on melons caused by *acidovorax avenae* subsp. *Citrullis* is a serious disease that has become a significant risk factor in many areas where melons are grown. Gummy stem blight (GSB) is caused by a fungus, *didymelia bryoniae*, that attacks melons and cucurbits. Yield loss due to GSB occurs as a result of rapid defoliation of vines and fruit infection and decay. The pathogen causing BFB of GSB can be introduced into a field by infested seed, infected transplants, cucurbits, mechanical means or natural spread for alternate hosts. It is impossible to conduct any test which has 100% reliable results in identification of any seed borne GSB or BFB. However manufacturers are doing their best to test and/or treat the melon seeds ad any seed sold is tested to current industry standards.

All seed sold by Martin's Produce Supplies is tested by the manufacturers and are warranted by the manufacturers that the test results have shown no evidence to BFB of GSB. But they cannot guarantee that the seeds are free of BFB or GSB. In no case shall Martin's Produce Supplies or the Manufacturer be held responsible for anything beyond the original purchase Price and if in any event Martin's Produce Supplies is forced to take legal action the purchaser shall be responsible for any legal/ attorney fees. Martin's Produce Supplies cannot be held responsible for any losses or damages relating to BFB and/or GSB. No warranty is given to any melons or cucurbits.

Seeds are sold only in the package sizes listed below. Prices are per lb or per m



Vacuum Seeder

- An economical, fast, and easy way of seeding seeds into trays
- Seed plates are made of aluminum and are very easy and quick to change via clamps
- Easy to use, Hook up a vacuum to hose, spread seeds over plate and seeds will be vacuumed to the micro holes in plate, flip seeder box to the side with the seed reservoir section down and excess seed will fall into seed reservoir section, then turn the over the seeder box upside down over the tray and close valve to cut vacuum and seeds drop into tray
- Multiple tray sizes available

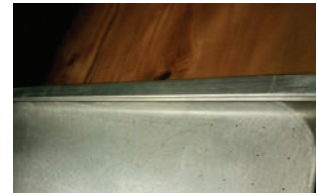

ITEM #		PRICE
VACSEB	Vacuum Seed Box	\$175.41
VAC72C	72 Vacuum Seed Tray	73.45
VAC128C	128 Vacuum Seed Tray	78.99
VAC200C	200 Vacuum Seed Tray	84.54
VAC288C	288 Vacuum Seed Tray	87.31

Coconut Coir



Coconut Coir Grow Bags 5 Gal

Set these coir grow bags in place, add water to expand the coco coir media and plant. These grow bags are popular for tomatoes, cucumbers, berries and cannabis. Grow bags come complete and include coco coir block. Drainage holes are predrilled. Bags are available in 3 or 5 gallon size.

- Convenient • Pre-Washed • LOW EC • pH 5.6-6.5

ITEM #	DESCRIPTION	PRICE	100+	300+
COCCOGP5	Coconut Coir Grow Pots, 5 GAL	4.25	\$3.69	\$3.49
COCCO	2 cuft Coconut Coir Blocks			
COCCOL1.5	Coconut Coir Loose Bags, 1.5 cu ft			

NEW ITEM! Dutch Bucket with Siphon Elbows

A hydroponic Dutch bucket system with 2.9 gallon capacity. Each Dutch bucket is connected to a nutrient supply line. The most common method is drip irrigation where a regulated flow of nutrient solution is delivered to each bucket through a small tube.

The nutrient solution provides water and essential nutrients to the plants. The hydroponic Dutch bucket system offers a compact and manageable solution for growing plants hydroponically. It is suitable for small-scale operations or when space is limited. By delivering controlled nutrient solutions and maintaining a stable growing environment, this system can help optimize plant growth and maximize yields.



High quality hydroponic Dutch buckets for greenhouse are designed to be fed by drip emitters and plumbed to drain into a 1.5" PVC pipe. Siphon elbows regulate the safety reservoir of nutrient solution at the bottom of the bucket to 1" deep. This feature prevents the growing medium from drying out and causing stress between irrigation cycles. Siphon pipe also prevents over accumulation of nutrient solution. Two siphon elbows are recommended per each bucket. You can use just about any type of growing media, including perlite and coconut coir. Ideal for tomatoes, cucumbers, peppers, scallions, basil, other herbs and much more!

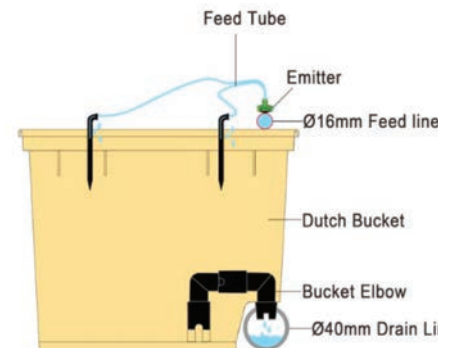

THIS ITEM IS NOT STOCKED, YOU MUST PREORDER THIS BUCKET AHEAD OF TIME.

ITEM #	DESCRIPTION	GAL	PRICE	100+
DUTBU	Dutch Bucket with Siphon Elbows	2.9	\$4.75	\$4.51



A HUBER COMPANY

Why Miller?

HERE'S WHY!

Miller is your trusted partner for exceptional crop production. At Miller we've been solving the tough problems for growers globally for over 80 years. Leading the way in science, experience and education, we develop products specifically engineered to deliver superior results, one crop at a time.

- Our team is comprised of highly trained agronomists, horticulturalists, and crop advisors who provide technical support and product programs designed to maximize return on investment
- Miller makes sure that raw materials used contain the lowest possible level of chlorine and in some cases, are totally free of chlorine
- Miller only uses 100% EDTA chelated micronutrients

Standard Macronutrients



MIL320, 20-20-20

Nutri-Leaf® 20-20-20 + Micros is a balanced soluble nutrient fertilizer of high technical grade with micro elements. It is designed to increase the yields of the crops throughout their growth cycle where balanced fertility is required for vegetative and crop development.

ITEM #	QTY/WEIGHT	PRICE	10+
MIL320	25 lb	\$46.55	\$45.62



Crop Finisher 4-2-41

Crop Finisher® 4-2-41 + 2% Mg is a unique potassium formulation with EDTA chelated minor elements and increased magnesium designed to provide crops the required nutrition necessary for finishing late season development.

ITEM #	QTY/WEIGHT	PRICE	10+
MIL4241	25 lb	41.7	\$43.64



Nutri-Chem 9-15-30

NutriChem® 9-15-30 + Micros is a fertilizer for use during periods of high demand for potassium, such as at fruiting and maturation.

ITEM #	QTY/WEIGHT	PRICE	10+
MIL91530	25 lb	46.02	\$48.95



Sol-U-Gro 12-48-8

Sol-U-Gro® 12-48-8 + Micros is a fertilizer to be used when crops demand increased levels of phosphorus such as at transplanting, at bloom and late season to secure bud formation on fruit trees.

ITEM #	QTY/WEIGHT	PRICE	10+
MIL12488	25 lb	48.91	\$45.60

Miller 20-5-5 w/minor elements

General use: 5 - 10 lbs per acre. use this product as a foliar application to supplement the normal soil applied fertility program. Can be applied by aircraft at rates equivalent to one pound in one gallon of water, per acre. For back pack sprayers use at the rate of 6 grams per liter or 4 tsp/gallon.

ITEM #	QTY/WEIGHT	PRICE
MIL2055	25 lb	44.51

Specialty Macronutrients



Sugar Express 4-10-40

Sugar Express® 4-10-40 is a highly refined fertilizer with the appropriate ratio of phosphorus and potassium designed to be used close to harvest. Sugar Express is a premium quality foliar fertilizer, unique in the market and exclusively offered by Miller.

ITEM #	QTY/WEIGHT	PRICE
MIL41040	25 lb	98.3



Nutrient Express 4-41-27

Nutrient Express® 4-41-27 is a unique blend of phosphorus and potassium for use during fruit formation and under heavy crop loads.

ITEM #	QTY/WEIGHT	PRICE
MIL44127	25 lb	159.64



Cell Force Max 6-0-0

Cell Force® MAX 6-0-0 is a liquid specialty fertilizer that is powered by S.M.A.R.T. technology. Designed to reduce calcium disorders and cellular leakage in plants.

ITEM #	QTY/WEIGHT	PRICE	2+
MIL600	2.5 gal	89.49	\$96.77

Miller's Supreme 16-4-13

Limit of solubility = 3 lbs per gal. Vegetable crop use rates of 3-5 lb per acre per day for a supplemental feeding through drip irrigation. Ornamentals use rate of: 1-100 ratio @ 200 PPM = 16.67 oz per gal. 1-100 ratio @ 300 PPM = 25 oz per gal. rate of: 1-100 ratio @ 300 PPM = 25 oz per gal.

ITEM #	QTY/WEIGHT	PRICE	10+
MIL16413	25 lb	84.59	\$79.47

Biostimulants



Greenstim 2-8-14

Greenstim® 2-8-14 is a proprietary liquid fertilizer combined with plant betaines to promote vigorous root and plant growth during periods of environmental stress.

ITEM #	QTY/WEIGHT	PRICE	10+
MIL250	2.5 gal	179.5	\$184.25

TerraGrow

TerraGrow is a powdered blend of carefully selected beneficial bacterial and fungal spores that was developed to improve soil characteristics and plant stress tolerance. TerraGrow quickly reestablishes beneficial bacteria and fungi populations in and around the root zone.

TerraGrow can be used throughout the growing season to improve soil health and plant vigor. Use in conjunction with TerraClean 5.0 bactericide/fungicide for a complete soil treatment program.



ITEM #	QTY/WEIGHT	PRICE
TERGR	Terra Grow 4 lb	111.69
TERGR10	Terra Grow 10 lb	191.88

MycoApply Ultrafine Endo

MycoApply® Ultrafine Endo is a suspendable powder mycorrhizal inoculum consisting of 4 species of endomycorrhizal fungi. About 85% of the world's plant species form symbiotic relationships with this type of symbiotic soil fungus. These beneficial fungi greatly increase the effective rooting area of plants, thereby enhancing plant growth, vigor, and tolerance of environmental extremes. MycoApply® Ultrafine Endo is a concentrated, fine, suspendable material with a particle size less than 300 microns (will pass a #50 screen) containing mycorrhizal propagules, which colonize roots and extend into the surrounding soil forming an essential link between plants and soil resources. Increasing the rooting area allows improved access to water and nutrients, promoting plant quality and crop performance.

We are now carrying the MycoApply Injector Endo which is very concentrated that will treat 500 gallons where the MycoApply Ultrafine Endo will treat 37 gallons.



ITEM #	DESCRIPTION	PRICE
MYCULE	MycoApply Ultrafine Endo, 1LB Bag	34.24
MYCINE	MycoApply Injector Endo - 100 G Bag	\$0.00



MILCALFA, C.A.L.F.A. 2.5 Gal.

C.A.L.F.A.® is a proprietary blend of 40% nature-based carboxylic acid solution designed to release soil nutrients into plant available forms during critical plant growth and development stages. This product enhances calcium, phosphate, and micronutrient uptake while solubilizing and leaching sodium in high sodium soils.

ITEM #	QTY/WEIGHT	PRICE	4+
MILCALFA	1 gal	157.7	\$0.00



Cytoplex HMS

Cytoplex® HMS is a Plant Hormone Supplement consisting of EPA-registered sea plant extracts in addition to gibberellic acid and indole-3-butyric acid. This product enhances root development.

ITEM #	QTY/WEIGHT	PRICE	4+
MIL99	1 gal	123.17	\$132.90

Micronutrients

Mag-Si Chelated Magnesium

5% Magnesium & .5% Silicon 5lb bags, A chelated product for plants needing extra magnesium.

ITEM #	QTY/WEIGHT	PRICE	10+
MILMAGSI	5 lb	56.83	\$61.85



Microplex

Microplex® is a chelated EDTA blend of eight micronutrients designed for maximum plant response in foliar or soil applications. Compatible with phosphate-based fertilizers.

ITEM #	QTY/WEIGHT	PRICE
MIL102	5 gal	44.73

Borpower, Boron 10%

BorPower is used on field crops, tree fruit, vegetables, and ornamentals for the prevention and correction of Boron deficiencies. Also can be used with a starter fertilizer if it does not come in direct contact with the seed.

ITEM #	QTY/WEIGHT	PRICE
POWAGBO	2.5 gal	72.53

Calcium Nitrate (ag grade)

For side dressing only. (Does not dissolve easily. 15.5-0-0 + 19% Calcium.

ITEM #	QTY/WEIGHT	PRICE
CNA50	50 lb	25.83



Mono Potassium Phosphate 00-52-34, (water soluble)

The preferred source of phosphorus and potassium when nitrogen fertilization should be limited. Can be applied in combination with other fertilizers to meet crop nutritional needs throughout the growth cycle.

- At the early stages of the growth season when phosphorus and potassium are needed at high rates for the establishment of root system.
- During the productive stages of sugar-rich fruit crops, to increase sugar content and to improve fruit quality.
- Fully water-soluble.
- Consists of 100% plant nutrients.
- Free of chloride, sodium and other detrimental elements for plants.
- Safe for plants and humans, due to moderately low pH and low salt index.

ITEM #	QTY/WEIGHT	PRICE
MPP50	55 lb	89.6



ZMC Express

ZMC Express® is a chelated EDTA blend of micronutrients. It is used for treatment of soils and crops where micronutrient deficiency is diagnosed or suspected.

ITEM #	QTY/WEIGHT	PRICE
MIL101	5 lb	47.36

Iron Chelate

Iron DP® 10% is based on DTPA chelating agent. Provides maximum iron availability in soil pH ranges from 6-8.

ITEM #	QTY/WEIGHT	PRICE	10+
MIL93	5 lb	62.11	\$60.88



Calcium Chelate

Calcium Chelate 9.5% EDTA is an excellent foliar or soil applied source of calcium to plants. Compatible with phosphate-based fertilizers through drip systems.

ITEM #	QTY/WEIGHT	PRICE	10+
MIL95	5 lb	40.25	\$41.47

Sulfate of Potash

Potassium Sulfate of Potash Water Soluble 0-0-52 is OMRI listed and the main source of chlorine-free natural potassium and a necessary complement to achieve high-quality and nutrient balanced crops. Besides making the crop more drought resistant, potassium produces tastier, healthier and more colorful fruits and vegetables with extended shelf life. Potassium is completely water-soluble and contains 52% soluble potash and 18% sulfur.

ITEM #	QTY/WEIGHT	PRICE
SF0052	52 lb	52.16

Nutri - Cal 2.5Gal

Nutri-Cal® liquid calcium solution for foliar application on fruit and vegetable crops is a unique formulation, consisting of T.O.G., an organic complexing agent which masks the calcium ion, creating a molecule that is easily absorbed and is efficiently transported throughout the plant to the fruit cells. There are no chlorides or sulfates. It has a low salt index and is therefore non-corrosive. Nutri-Cal® liquid calcium supplement improves firmness and storage life. University research and use by countless growers has proven the capability of Nutri-Cal® liquid calcium supplement to improve fruit quality and firmness -- increasing storage life. Longer storage life means marketing your product when Price is best and selling at premium Prices.



ITEM #	PRICE
NUTRI	\$99.27

Nitro-28® SRN 28-0-0

Nitro®-28 (28-0-0) is a proprietary liquid slow release nitrogen based on methylene urea technology. This product is a clear 28% nitrogen solution that contains 2.92 pounds of nitrogen in every gallon. Nitro-28 has an extended shelf life and ensures a stable product even when stored in below freezing temperatures. As with all Nitro products, Nitro-28 provides crops with the same proven results; a steady, uniform and non-phytotoxic supply of nitrogen for extended periods of time. Use as a foliar feed. Nitro-28 is rain fast in a matter of minutes.

All T-Growth Products available in 30 gal, 55 gal, and 275 gal. totes



ITEM #	PRICE
Nitro28	\$0.00

Nutri - K 2.5Gal

NUTRI-K is a special liquid formulation of highly soluble potassium and a unique complexing agent T.O.G.. This combination provides a high quality and readily available source of potassium to be utilized by plants. NUTRI-K contains NO nitrates, chlorides or sulfates. NUTRI-K has a low salt index and is non-corrosive. Nutri-K may be applied to a wide variety of horticultural, turf, greenhouse, ornamental and all agricultural crops. Potassium requirements for most crops increase during periods of rapid growth and fruit development. Application of Nutri-K should be made based on soil and/or plant tissue analysis for potassium.



ITEM #	QTY/WEIGHT	PRICE	2+
NUTRIK	2.5 gal	63.75	\$57.39

Calcium Nitrate (greenhouse grade)

Highly pure white very fine crystals. Easily and totally soluble calcium nitrate that dissolves like no other calcium nitrate. All nitrogen is in the nitrate form and it does not contain any ammonium nitrogen. It is a very low nitrogen with a high calcium content. Made in the USA.

ITEM #	QTY/WEIGHT	PRICE
CNG50	55 lb	27.42

Potassium Nitrate 13.5-0-46.2

Potassium nitrate is mainly used in fertilizers, as a source of nitrogen and potassium - two of the macronutrients for plants. When used by itself, it has an NPK rating of 13.5-0-46



ITEM #	QTY/WEIGHT	PRICE
PN50H	50 lb	59.18

Crop Production Aids



Vapor Guard

Vapor Gard® is a Pinolene® based product for use on specialty crops to reduce water evapotranspiration. Helps guard against frost damage and helps prevent transplant shock.

ITEM #	QTY/WEIGHT	PRICE	4+
MILVG	1 gal	59.83	\$62.51



Miller Hot Sauce Animal Repellent

Miller Hot Sauce repels deer, rabbits and mice. Effective on fruits, nut trees, vegetables, vine crops and ornamentals. Mix 4 ounces of Hot Sauce with 1 Quart of Vapor Gard to 50 gallons of water. Mix with Millers Vapor Gard to extend the effectiveness of the repellent. Not to be used once fruit is visible. Comes in a 1 gallon container .

ITEM #	QTY/WEIGHT	PRICE	10+
MILHS1	1 gal	246.17	\$277.52



Sulforix

Sulforix® is an EPA-registered fungicide, insecticide, and miticide with unique penetration capabilities into bud scales, wood tissue and plant surfaces. Use rates are lower than Lime Sulfur® and has many in season crop applications.

ITEM #	QTY/WEIGHT	PRICE
MIL82	2.5 gal	76.54



Reflections Crop Protectant

Reflections® is a blend of calcium acetate and calcium carbonate that provides 30% calcium in a soluble form. Due to its reflective nature, when it's applied to a plant the primary benefit is a reduction in heat stress and sunburn to the plant.

ITEM #	QTY/WEIGHT	PRICE
MILRE	2.5 gal	49.93

Hormodin 1 Rooting Powder

Hormodin is a root inducing plant hormone. Hormodin is a formulation of indole-3-butyric acid (IBA). IBA is a synthetic auxin rooting hormone, which acts as a root stimulant.



Hormodin enhances rooting, which reduces propagation bench time and plant loss. Hormodin is easy to use, yielding steadfast performance of rooted cuttings and zero disease migration.

To apply Hormodin, moisten cuttings, in particular the basal ends of the cuttings before treatment (except geraniums). Pour a small amount of Hormodin into a bowl or pan. Dip and stir basal ends of the cuttings in Hormodin. Remove excess powder by tapping on the rim of the container. Then, plant treated cuttings in rooting medium. Simply stated, "Dip it - Tap it - Stick it". Hormodin works best when used on fresh cuttings.

ITEM #	PRICE
HORROP	\$0.00

ORGANIC

Biostimulants

TerraGrow

TerraGrow is a powdered blend of carefully selected beneficial bacterial and fungal spores that was developed to improve soil characteristics and plant stress tolerance. TerraGrow quickly reestablishes beneficial bacteria and fungi populations in and around the root zone.

TerraGrow can be used throughout the growing season to improve soil health and plant vigor. Use in conjunction with TerraClean 5.0 bactericide/fungicide for a complete soil treatment program.



ITEM #	QTY/WEIGHT	PRICE
TERGR	Terra Grow 4 lb	111.69
TERGR10	Terra Grow 10 lb	191.88



Cytokin

Cytokin® is a plant-based EPA registered plant growth regulator used to improve nutrient utilization, promote bud and flower set, and improve fruit size.

ITEM #	QTY/WEIGHT	PRICE	4+
MIL97	1 gal	120.65	\$122.37

Adjuvants



CAPSIL

CapSil ensures uniform spreading and coverage of foliar directed sprays on the first application. You get the results you expect and avoid the expense of unnecessary repeat treatments. CapSil is a 100% active blend of organo-silicone and non-ionic surfactants that enables solutions to spread over the entire leaf surface evenly. Benefits of using CapSil include: Ensures uniformity and spreading of foliar applied products. Reduces disease incidence. Safe to use – no concern of burn.

ITEM #	QTY/WEIGHT	PRICE
ADJCAP	1 gal	\$175.86



Nufilm P Sticker Spreader

Nu-Film-P® is a superior deposition, spreader, and sticker adjuvant with non-ionic properties based on proprietary Miller technology containing Pinolene®. Extends the effective life of pesticides and is compatible with many commercially used pesticides.

ITEM #	QTY/WEIGHT	PRICE	4+
MILP	1 gal	55.77	\$54.66

Fungicides

Lime Sulfur

EPA registered fungicide-insecticide with no known resistance. Excellent dormant material that burns out overwintering inoculum.

ITEM #	QTY/WEIGHT	PRICE
MIL81	5 gal	102.09



A new generation of essential oil extracted from the thyme herb. Bactericide, fungicide, and insecticide for use in all crops, turfs and ornamentals. OMRI approved.

ITEM #	QTY/WEIGHT	PRICE
AGRRETH32	32 oz	25.99
AGRRETH1	1 gal	\$0.00

Herbicides

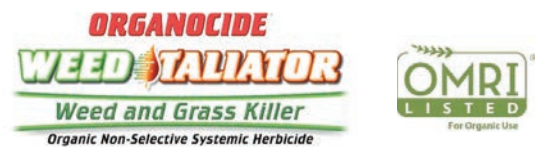

Proudly made in the USA, Weed Taliator is a systemic and broad-spectrum herbicide to tackle the toughest weeds. Comprised of thyme and eugenol essential oils that are paired with an exceptional surfactant, it will deliver control down to the roots of weeds. Control weeds in driveways, walkways, mulch and gravel beds, patios, pavers, fence lines, around shrubs and trees, and areas where unwanted weeds and grass are present.

ITEM #	QTY/WEIGHT	PRICE
AGRREW1	1 Gal	58.77

Insecticides



Lime Sulfur

EPA registered fungicide-insecticide with no known resistance. Excellent dormant material that burns out overwintering inoculum.

ITEM #	QTY/WEIGHT	PRICE
MIL81	5 gal	102.09



A new generation of essential oil extracted from the thyme herb. Bactericide, fungicide, and insecticide for use in all crops, turfs and ornamentals. OMRI approved.

ITEM #	QTY/WEIGHT	PRICE
AGRRETH32	32 oz	25.99
AGRRETH1	1 gal	\$1.00

Adjuvants

Spreader 820

Designed to use with pesticides that require a nonionic surfactant. May also be used with most insecticides and fungicides. Increases contact activity and provides uniform coverage.

ITEM #	QTY/WEIGHT	PRICE
ADJSPR	1 gal	18.86
ADJSPR2	2.5 gal	35.42

Fome-Kil

An anti-foaming and defoaming agent used as an additive to control foaming of chemicals.

ITEM #	QTY/WEIGHT	PRICE
ADJFOM	1 qt	12.29
ADJFOM	1 gal	12.29

Indicate 5

Adjusts pH and contains a built in pH indicator for sensitive chemicals. Just pour into spray tank until water turns a pink color then you know that the PH is at the optimum level of 4.5-5.5.

ITEM #	QTY/WEIGHT	PRICE
ADJIND5	1 qt	72.45

Peptoil

A blend of highly-refined Paraffinic oil designed to improve spray efficacy. Contains an anti-foam.

ITEM #	QTY/WEIGHT	PRICE
ADJPEP	1 gal	18.4
ADJPEP2	2.5 gal	37.78

Turbo PH Reducer

Used to reduce water pH for improved herbicide residual.

ITEM #	QTY/WEIGHT	PRICE
ADJTUR	2.5 gal	52.29



Nufilm 17 Extender Sticker Spreader

Nu-Film-17® is a superior deposition, sticker, and extender adjuvant with non-ionic properties based on proprietary Miller technology containing Pinolene®. Extends the effective life of pesticides and is compatible with many commercially used pesticides.

ITEM #	QTY/WEIGHT	PRICE	4+
MIL17	1 gal	58.57	\$57.42

FM 160 Foaming Concentrate

A foam-marker concentrate for use in field marking systems to help eliminate overlaps.

ITEM #	QTY/WEIGHT	PRICE
ADJFM160	1 gal	38.32

CleanOut Tank Cleaner

CleanOut aids in the reduction of spray tank residue. Since the amount of residue varies, individual conditions will directly affect use rates of CleanOut.

USE RATES, 1 quart of CleanOut treats up to 100 gallons of spray solution. Circulate cleaning solution throughout entire system. Use high pressure spray to clean and rinse interior of spray tank. Purge tank systems, spray lines and nozzles. Drain out and completely rinse tank again using clean water. Always use enough CleanOut to completely remove all residues.



ITEM #	QTY/WEIGHT	PRICE
POWAGCL	1 qt	15.17

Sulfuric Acid 66o Be', 93% Acid

An acid to reduce the PH in your water. Call for a quote on 50 Gal. Drums.

ITEM #	QTY/WEIGHT	PRICE
SUA1	1 Gal	\$20.22

Organic Bicarbonate Reducer

Citric Acid has the advantage over harsh mineral based "Hazmat" acids, like Nitric, Phosphoric or Sulfuric Acid, of being nonhazardous and easy to handle, easily dissolves in water and is highly compatible with other water soluble products.

- Powerful and fast acting pHreducer
- Nonhazardous and easy to handle
- Compatible with most water based add ons.

ITEM #	QTY/WEIGHT	PRICE
CITAC	25 lb bag	76.21



Spray Aide

Spray-Aide® is a versatile compatibility, acidifier, and surfactant. It is designed to improve spray tank compatibility of pesticides, lower the pH of spray tank water or liquid fertilizer solution, act as a spreader for use with pesticides, and to reduce soil crusting.

ITEM #	QTY/WEIGHT	PRICE	4+
MILSA	1 gal	52.56	\$52.15

Disinfectants

Sanidate 15.0, Disinfectant

Peroxyacetic acid-based chemistry is designed to be a versatile solution in many agribusiness applications. This sanitizer/ disinfectant treats and controls spoilage-causing organisms, as well as human health pathogens. Whether it's hard surface sanitation, postharvest wash water treatment, or irrigation systems and water treatment, SaniDate 15.0 is ideal for use throughout the production.



PERAGREEN® 5.6%



Peragreen® 5.6%

Peragreen® 5.6% Liquid Sanitizer/Disinfectant helps use applications on the market today. With Peragreen® 5.6%, you will use up to 65% less product than the competition for control of bacteria, slime, odor and algae when used on seeds, soil, pre-plant dip treatments, irrigation systems and foliar applications.

ITEM #	QTY/WEIGHT	PRICE
SAN15	5 gal	168.74

ITEM #	QTY/WEIGHT	PRICE	4+
MILSQ5.6	2.5 gal	71.06	\$65.45

Liquid Fertilizers

CELL POWER® LADY LUCK

A complete liquid fertilizer blend 10-10-10 with micronutrient and OMEX's proprietary EBA Technology. When applied to crops provides N-P-K and essential micronutrients that help with plant growth, reduce nutrient deficiencies and aid in reducing abiotic stress. BALANCED can be applied foliar or through drip irrigation at 1-4 quarts/acre. See label for full recommendations and compatibility.



CELL POWER® LEAF ACT™ #1

A complete high Phosphorus liquid blend fertilizer 3-13-7 with essential micronutrients and OMEX's proprietary EBA Technology. Apply early in the season following transplanting or seeding for strong early root development and increased photosynthesis. LEAF ACT™ #1 can be applied foliar or through drip irrigation at 1-4 quarts/acre. LEAF ACT™ #1 may also be applied any time throughout the season when crops are showing signs of P deficiencies. See label for full recommendations and compatibility.



ITEM #	QTY/WEIGHT	PRICE	2+
OMX101010	2.5 gal	86	\$73.62

ITEM #	QTY/WEIGHT	PRICE	2+
OMX3137	2.5 gal	72.53	\$58.90

NEW ITEM! Introducing our new testing program,

This program is to give growers options for where to go for various forms of crop tests during the season and off-season. There are many benefits to performing a soil, plant tissue and Irrigation water test. Optimizing crop production, correction of pH in soil and water and learning what nutrients are lacking at the appropriate times are just a few pros to this kit. This comprehensive test kit includes 1-soil test, 2-water tests, and 6-plant tissue tests. Each test kit box includes a package or bottle for test material for each test, and a prepaid box with a label to send the sample into the laboratory. Your job is to collect samples of water, soil or plant tissue, place in package or bottle and put it in the box and put it in the mail. Once the results come back, we can either send you the results for your own fertilization program or have our consultant give you recommendations on a fertilization program. If you need to do a separate test, you can purchase each test separately instead of the complete kit.

ITEM #	QTY/WEIGHT	PRICE
TEST/COMPLETE	Soil Test, Water Test, Plant Tissue Test	\$0.00
TEST/LEAF	Plant Tissue Test	\$0.00
TEST/SOIL	Soil Test	\$0.00
TEST/WATER	Water test	\$0.00

TYPE	WHAT TO TEST	TEST TIMING
Soil	pH, CEC, All Nutrients	Early Fall up until before planting
Plant Tissue	All Nutrients- Including Micros	Once/month during growing season
Water	pH, Hardness, Sodium & Chloride	1-before production, 1- during

CELL POWER® LEAF ACT™ #2

A complete higher Potassium liquid blend fertilizer 3-6-13 with essential micronutrients and OMEX's proprietary EBA Technology. LEAF ACT™ #2 can be applied foliar or through drip irrigation during reproductive growth stages of plant development at 1-4 quarts/acre to improve growth and development. Apply LEAF ACT™ #2 throughout the seasons as a finisher fertilizer to increase sugars, fruit size, protein synthesis and maturity in a wide range of crops. See label for full recommendations and compatibility.

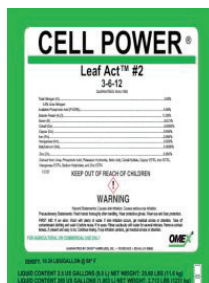

ITEM #	QTY/WEIGHT	PRICE	2+
OMX3612	2.5 gal	75.9	\$68.71

CELL POWER® SizeN® 15-0-7

An innovative product that supplies nitrogen in a form that encourages compact shoot growth, better rooting, and better fruit development. SizeN® 15-0-7 is a stabilized Amine Nitrogen with potassium nitrate that encourages reproductive growth and root development as well as starch synthesis, sugar, water and nutrient transport. Apply SizeN® 15-0-7 at 2 quarts/acre through drip irrigation, foliar, center pivot, solid set and micro-irrigation systems. See label for full recommendations and compatibility.

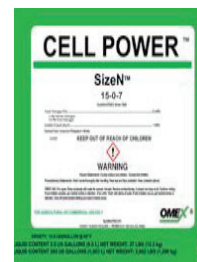

ITEM #	QTY/WEIGHT	PRICE	2+
OMX1507	2.5 gal	\$99.51	\$96.52

CELL POWER® K25

A powerful blend of urea, potassium carbonate and Ascophyllum nodosum provides a great way of supplying extra potassium as a foliar spray to crops during periods of high demand for K. The Ascophyllum nodosum seaweed is present to help increase the cell division in the harvestable portion of the crop. Apply K25 at 1-2 quarts/acre foliar as needed, every two weeks to increase sugar production and movement into target sink tissue. See label for full recommendations and compatibility.

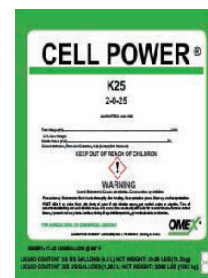

ITEM #	QTY/WEIGHT	PRICE	2+
OMXK25	2.5 gal	69.15	\$84.49



Fertilizers

CELL POWER® Calcium Gold 7-0-0

A calcium nitrate formulation with a unique calcium delivery system. Calcium Gold contains pioneering LoCal Technology which supports the plants natural processes to enable Calcium absorption where a plants natural system is unable. Apply Calcium Gold foliar at the rate of 1- 4 quarts/acre from flowering throughout the season for firmer, larger fruit with increased Brix and stronger shelf life. See label for full recommendations and compatibility.



ITEM #	QTY/WEIGHT	PRICE	2+
OMX700	2.5 gal	89.39	\$80.17

CELL POWER® OMEX SLYCE 8% Calcium

SLYCE®Ca8%: Is a soil amendment derived from calcium nitrate and humic acid to aid in improving water penetration and soil tilth. SLYCE®Ca8% applied to the soil through irrigation or side dressed at the rates of 1-5 gallon per acre; reacts with soil nutrient components and creates a faster and more efficient availability of nutrients. See label for full recommendations and compatibility.



ITEM #	QTY/WEIGHT	PRICE	2+
OMX6.5008	2.5 gal	59.03	\$57.26

CELL POWER®Zynergy

A synergistic blend of copper, zinc and sulfur and OMEX proprietary blend of organic acids. Zynergy™ reduces zinc, copper and sulfur deficiencies and improves overall vigor of plants throughout the growing season. Apply Zynergy™ foliar, at the rate of 8 to 16 oz/ acre as needed throughout the growing season to improve plant health and vigor. See label for full recommendations and compatibility.

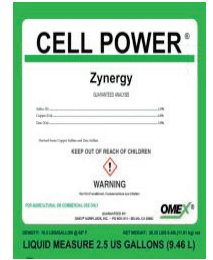

ITEM #	QTY/WEIGHT	PRICE	2+
OMXZY	2.5 gal	82.65	\$73.33

CELL POWER® OMEX 4pHoric®

A unique phosphorus and potassium blend 4pHoric® contains 20% plant available phosphates and 16% phosphite. The nutrients are derived from a controlled blend process using mono-potassium phosphate and phosphorous acid. Add OMEX 4pHoric® to your tank mix to establish roots and encourage root hair development to improving nutrient uptake. Apply OMEX 4pHoric® at the rate of 3- 8 pints/acre starting early season. See label for full recommendations and compatibility.

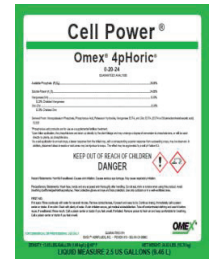

ITEM #	QTY/WEIGHT	PRICE	2+
OMX4PHORIC	2.5 gal	116.53	\$101.43





Plant Marvel 12-45-10 Fertilizer, Starter

A starter solution which aids plants in rooting faster. It helps overcome transplanting shock and is widely used in greenhouse and nursery operations to correct and supplement low phosphorous levels in established plantings. It is also very effective in promoting blossoming. Young vegetable plants being set in the field respond especially well to this starter formula. Use for seedling, transplants and rooted cuttings.

ITEM #	QTY/WEIGHT	PRICE	10+
PM124510	25 lb	36.88	\$44.36

Plant Marvel 20-20-20

Nutriculture General Purpose 20- 20-20 provides over 60% nutrient value in a 1-1-1 ratio which makes it suitable for general use in a wide variety of growing situations. It is widely used on containerized stock in the nursery industry and for greenhouse crops such as foliage plants and bedding plants. For institutional and general landscape maintenance, it is ideal because it works well on turf, trees or shrubs as well as blooming plants and can be used as a single all-purpose spray feed.

ITEM #	QTY/WEIGHT	PRICE	10+
PM202020	25 lb	34.31	\$38.06

Plant Marvel 5-12-26 Hydroponic Special

Formulated to compliment calcium nitrate in a two-part hydroponic system. May be used at different mix rates.

ITEM #	QTY/WEIGHT	PRICE
PM51226	25 lb	37.93

Plant Marvel 20-3-19 Fertilizer

With three forms of Iron for improved availability at various substrate pH levels.

ITEM #	QTY/WEIGHT	PRICE
PM20319	25 lb	35.47

Plant Marvel 9-15-30 Fertilizer, Finisher

A high potash (K) formula that can be used to finish vegetable crops. It can also be used to overcome potash deficiency, build up resistance to fungus and disease, give strength to and build up fibrous qualities of stems and leaves as well as fruit.

ITEM #	QTY/WEIGHT	PRICE
PM91530	25 lb	34.77

Ezi-action Drum Pump

Ezi-action® 200/55 Drum Pumps have provided safe, effortless dispensing since their conception in 1991.

Empties all contents from container. Vertical location of pump in the drum means no bending and no risk of back injury or back ache when dispensing liquid. Heavy 55 Gal. containers can remain in a safe, upright position. Customers can confidently buy in bulk, reducing overhead costs. Can also be used for pumping from 25 gallon drums. Recognized as the best hand drum pump in the world.



ITEM #	QTY/WEIGHT	PRICE
SUADP50	Fits 55 gal Drum	56.27

Insecticide Reference Chart

Chemicals

INSECT	PRODUCT																																				
	Acephate	Adept	Akari SC	Aria	Astro	Attain TR	Avid	Azatin	Beethoven TR	Benefit 60WP	BotaniGard 22ZWP	BotaniGard ES	Citation	Conserve	Deadline	Decathlon	Dimilin 25W	DIPel	Discus	Distance	Dormant Oil	Duraguard ME	Duraplex TR	Dursban	Endeavor	Enstar AQ	Flagship 25WG	Flagship G	Floramite SC	Gnatrol WDG	Hachi-Hachi	Hexygon	Judo	Kontos			
Ants	X				X														X			X															
Aphids	X			X	X	X	X		X	X	X					X			X	X	X	X	X	X	X	X	X	X			X				X		
Armyworms	X	X			X	X		X						X		X	X	X	X					X													
Bagworms	X				X	X		X						X		X	X	X	X					X													
Beetles	X				X			X		X	X	X				X			X			X		X				X	X								
Borers																				X				X													
Cankerworms	X				X			X								X	X	X	X					X													
Caterpillars	X				X	X		X						X		X	X	X	X				X	X													
Chafer								X		X													X						X								
Fungus Gnats		X			X	X		X			X		X			X			X	X		X	X				X	X			X						
Grasshoppers	X															X			X					X													
Lacebug					X				X							X			X					X				X									
Leafhoppers	X			X	X			X		X	X					X			X			X		X				X			X			X		X	
Leafminers		X			X		X	X		X			X	X			X		X	X		X															
Leafrollers	X				X	X		X						X		X		X																			
Loopers						X								X			X	X																			
Mealybugs	X		X	X	X	X		X		X	X	X				X			X	X		X	X	X			X	X	X								X
Mites			X			X	X		X					X		X			X		X	X	X	X					X					X	X	X	
Plant Bug				X	X	X				X	X					X			X			X		X				X									
Sawflies	X				X			X		X				X		X	X		X										X								
Scale	X			X		X			X							X			X	X	X	X	X	X			X	X					X				
Shore Flies		X											X								X		X	X													
Slugs & Snails															X				X																		
Spittle Bugs																X			X					X													
Thrips	X			X	X	X	X	X		X	X	X		X		X			X			X	X	X			X							X			
Webworms	X				X									X		X	X	X	X					X													
Whiteflies	X	X		X	X	X	X	X	X	X	X	X				X	X		X	X			X	X	X	X	X	X	X			X		X	X	X	

Lucid	M-Pede	Mallet	Mantra 1G	Marathon 1G	Marathon 60WP	Marathon II	Mavrik Aquaflo	Mesuro 75WP	Molt-X	Nemasys	Ornazin	Orthene TR	Ovation	Overture	Pedestal	Preclude TR	Pylon	Pyreth-It	Pyrethrum TR	Safari	Sanmite	Scimitar GC	Sevin SL	Shuttle O	Sirocco	Sluggo	Talstar Professional	Talus	Tame 2.4EC	Tame/Orthene TR	TetraSan	Triact	Tristar	Ultra-Pure Oil	UP-Star SC	X-Clude Formula 2	Zenith .5G		
	X						X											X	X			X	X				X									X	X		
X	X	X	X	X	X	X	X	X	X		X	X				X		X	X	X		X	X		X		X		X	X		X	X		X	X	X	X	
							X							X	X			X	X			X	X				X		X								X		
																				X	X		X	X				X									X		
	X	X	X	X	X	X	X		X		X							X	X	X		X	X				X		X					X	X	X	X	X	X
		X							X		X									X		X						X									X		
							X	X			X	X		X		X	X	X				X	X					X		X						X	X	X	X
																						X	X																X
	X	X	X	X	X	X						X							X	X		X	X					X		X	X					X	X	X	X
	X	X	X	X	X	X	X		X		X	X				X			X	X		X	X				X	X	X	X					X	X	X	X	
X	X						X	X			X	X				X	X	X	X		X	X		X	X		X		X	X	X	X	X	X	X	X	X	X	
	X																																						
	X	X				X	X		X																														
	X	X	X	X	X	X			X		X	X				X			X	X		X					X	X	X	X					X	X	X	X	
	X										X																												
							X												X						X														
								X		X													X	X															
X	X	X	X	X	X	X	X	X	X	X	X	X		X	X	X	X	X	X	X		X	X		X		X		X	X	X				X	X	X	X	
												X		X					X				X	X				X		X						X	X		
X	X	X	X	X	X	X	X		X		X	X				X	X	X	X	X	X		X	X		X		X	X	X	X				X	X	X	X	

Herbicides

ITEM #	DESCRIPTION	SIZE
HER24D	24D Amine Herbicide	1 gal
HER24D2.5	24D Amine Herbicide 2.5 gal. (Weedar)	2.5 gal
HERARS	Arsenal Powerline Herbicide (1 QT)	1 qt
HERCOM	Command 3ME Herbicide	2.5 gal
HERDEV	Devrinol DF XT Herbicide (4 LB)	4 lb
HERDIC	Dicamba HD Herbicide (Sterling Blue)	2.5 gal
HERGLY	Glyphosate (2.5 Gal.)	2.5 gal
HERGOA	Goal 2XL Herbicide (2.5 GAL)	2.5 gal
HERGRA	**Gramoxone SL Herbicide (2.5 GAL)	2.5 gal
HERLIB	Glufosinate 280 SL (2.5 gal)	2.5 gal
HERLUM	**Lumax EZ (2.5 gal)	2.5 gal
HERMAT	Matrix SG Herbicide (20 OZ)	20 oz
HERMET	Me-Too-Lachlor II Herbicide (2.5 GAL)	2.5 gal

ITEM #	DESCRIPTION	SIZE
HERPER	Permit 75WG Herbicide (20 oz)	20 oz.
HERPOA	Poast Herbicide (2.5 GAL)	2.5 gal
HERPRE	Prefar 4E Herbicide (2.5 GAL)	2.5 gal
HERPRO	Prowl H2O Herbicide (2.5 gal)	2.5 gal
HERQUI	**Quik Quat Herbicide. (Paraquat)	2.5 gal
HERSAN	Sandea Herbicide (10 OZ)	10 oz
HERSIN	Sinbar 80W Herbicide (5LB)	5 lb
HERSNA	Snapshot Herbicide 2.5 TG (50 lb)	50 lb
HERSTI	Stinger 3S Herbicide, 1 qt	1 qt
HERSTR	Strategy Herbicide (2.5 GAL)	2.5 gal
HERTRIME	Triad Select, generic, for Trimec Classic	1 gal
HERWER	Weedar Herbicide 1 gal.	1 gal

Call For Herbicide Pricing

**Requires Pesticide Applicator License to Purchase

We are pleased to bring you a wide selection of effective and excellent options of insect control agents. Please refer to the chart on pages 40 to see what product effectively deals with which pests.



Insecticides

ITEM #	DESCRIPTION	SIZE
INSAB	Minx Insecticide (Merlin)(Abamectin) 1 Qt.	1 qt
INSACE	Acephate 97UP Insecticide (1 lb)	1 lb
INSACR	Acramite 50 WS Insecticide (1 lb)	1 lb
INSACT	Actara Insecticide (30 oz.)	30 oz
INSADE	Adept Insecticide (1 lb.)	1 lb
INSASC	Ascertain TR Insecticide (2 fl. oz) (Attain)	2 fl oz
INSARVIDA	Arvida 30 SG (Assail) Insecticide 64 oz	64 oz
INSAV	Avid Insecticide (8 fl. oz.)	8 fl oz
INSAVI	Avid Insecticide (1 qt)	1 qt
INSAZ	Azaguard Insecticide (1 qt)(OMRI)	1 qt
INSBAY	**Baythroid XL Insecticide/Miti- cide(.5 gal)	1 gal
INSBE	Beleaf 50 SG, (1.5 lb.)	1.5 lb
INSBRI	**Brigade 2EC Insecticide/Miticide (1 gal)	1 gal
INSBRIW	**Brigade WSB Insecticide/Miticide (2.5lb)	2.5 lb
INSCAR	Carbaryl 4L Insecticide (2.5 gal)	1 gal
INSCAP	Captiva Prime Insecticide (1 qt.)	1 qt
INSCO	Conserve Sc Insecticide 1 (Qt)	1 qt
INSCOR	Coragen Insecticide (qt)	1 qt
INSDAN	**Danitol 2-4 EC Insecticide (1 gal)	1 gal
INSDEA	Deadline Bullets (Tan) Insecticide (50 lb)	50 lb
INSDDEL	Delegate WG Insecticide (26 oz)	26 oz
INSDEV	Devenir Pesticide (15 oz) (Endeavor)	15 oz
INSDIP1	Dipel DF (1 lb)	1 lb
INSDIP2	Dipel ES Insecticide (2.5 gal.)	2.5 gal
INSENV	Endeavor Insecticide (15 oz)	15 oz
INSENZC	**Endigo ZCX (1 Gal) (Pyrethroid)	1 gal
INSFUL	Fulfil Insecticide (27.5 oz)	27.5 oz
INSGRA	Grandevo Bioinsecticide 6lb.	5 lb
INSKON	Kontos Miticide Insecticide (250 ML)	250 ML
INSLAN	**Lannate 90 SP Insecticide (.5 LB)	.5 lb

ITEM #	DESCRIPTION	SIZE
INSLAN2	**Nudrin SP Insecticide (2 LB)(Lannate)	2 LB
INSIMA	Imidan 70 WSB Insecticide (5 lb)	5 lb
INSMAC	Macho 2.0 FL Insecticide (1 PT)(Admire PRO	1 pt
INSMAC1	Macho 2.0 FL Insecticide (1 gal)(Admire Pro	1 gal
INSMAI	Mainspring Insecticide (1 PT)	1 pt
INSMAL	Malathion 5 Insecticide (1 GAL)	1 gal
INSMARA	Marathon 1% G Insecticide (5lb)	5 lb
INSMUS	**Mustang Maxx EC Insecticide (1 GAL)	1 gal
INSNUD	**Nudrin LV Insecticide (2.5 GAL)	2.5 gal
INSOBE	Oberon 2 SC Insecticide (1 GAL)	1 gal
INSPER	**Perm Up 3.2 EC Insecticide (1 Gal)	1 gal
INSPI	Piston Insecticides (1 qt) (Pylon)	1 qt
INSPITR	Piston Insecticide TR (2oz.) (Pylon)	2 oz
INSPLA	Platinum 75 SG Insecticide (32 OZ)	32 oz
INSPOR	Portal Insecticide (2.5 GAL)	2.5 gal
INSPRO1	**Province II Insecticide (1 GAL) (Warrior)	1 gal
INSPY	Pyrus Pyrethrum TR. (2 OZ.)	2 oz
INSPYG	Pyganic EC 5.0, OMRI (1 QT)	1 qt
INSRAD	Radiant SC Insecticide (1 qt)	1 qt
INSSA	Safari Insecticide (3 lb)	3 lb
INSSA12	Safari Insecticide (12 oz)	12 oz
INSSEV	Sevin XLR Insecticide (2.5 gal)	2.5 gal
INSSLU	Sluggo Insecticide (50 lb) OMRI	50 lb
INSSUFX	Suffoil-X OMRI (2.5 gal)	2.5 gal
INSSUL	Sultan (Miticide) (1 Pt)	1 pt
INSTAL	Talstar Pro Insecticide (1 gal)	1 gal
INSTI	**Timectin EC Insecticide (miticide)	1 gal
INSTIQRT	**Timectin EC Insecticide (miticide) 1 QRT	1 QRT
INSTRI	Trilogy Insecticide (2.5 gal)	2.5 gal
INSVE	Venerate, 2.5 gal (OMRI)	2.5 gal
INSVEN	Venom 70 SG Insecticide (1 lb)	1 lb

Call For Herbicide Pricing

**Requires Pesticide Applicator License to Purchase

Fungicides

We are pleased to bring you a wide selection of effective and excellent options of fungus control. Please refer to the chart on page 43 to see what product effectively deals with which fungus.

ITEM #	DESCRIPTION	SIZE
FUNACT	Actigard Fungicide (8 oz)	5 oz
FUNACTAG	Actinovate AG	18 oz
FUNACTIRON	Perfect Ammendment (50 lb) (Actino Iron)	50 lb
FUNAFR1	Affirm Fungicide (2.4 lb)	2.4 lb
FUNBA	Banrot Fungicide (2 lb)	2 lb
FUNAL	Alterity Fungicide (Generic for Switch)	28 oz
FUNBRA	Bravo Weatherstick Fungicide (2.5 gal)	2.5gal
FUNBADSC	Badge SC Fungicide (2.5 gal) (group 11)	2.5 gal
FUNCAB	Cabrio Fungicide (5 lb)	5 lb
FUNCAP2	Captan 4L Fungicide (2.5 gal)	2.5gal
FUNCAP806	Captan 80WDG -	6.25 lb
FUNCAP83	Captan 80WDG - Albaugh Fungicide (30 lb)	30 lb
FUNCE	Cease Fungicide (1 gal.) ORGANIC	1 gal
FUNCHA	Champ Formula 2 Fungicide (2.5 gal)	2.5gal
FUNCOMMA	Companion Maxx (Turf & Ornamental)	1 qt
FUNCOWP	Companion Fungicide 2-3-2 (5 LB) OMRI	5 lb
FUNDE	Decree Fungicide	2.5 lb
FUNDIT	Dithane F45 Fungicide (2.5 gal)	2.5gal
FUNEA	Eagle 20 EW Fungicide (1 pt.)	1 pt
FUNELE	Elevate 50WDG Fungicide (2 lb)	2 lb
FUNEQU	Echo 720 Fungicide (Bravo)	2.5gal
FUNFON	Fontelis Fungicide (80 oz)	80 oz
FUNGME	Medallion Fungicide (8 oz)	8 oz
FUNGPY	Phyton 35 Fungicide	1 L
FUNGSU	Subdue Maxx Fungicide (1 qt)	1 qt
FUNGTRL	Truban 25EC Fungicide (1 qt.)	1 qt

ITEM #	DESCRIPTION	SIZE
FUNHAR	Harbour Fungicide (2 lb) (Agri-Mycin 17)	2 lb
FUNIND	Indar Fungicide (1 Gal)	1 lb
FUNINS	Inspire Super Fungicide (1 gal.)	1 gal
FUNKOC	Kocide 3000 Fungicide (4 lb)	4 lb
FUNKOC1	Kocide 3000 Fungicide (10 lb)	10 lb
FUNKUM	Sulfur Fungicide, (Microthiol) (30 lb)	30 lb
FUNMAN	Manzate Pro-Stick Fungicide (6 lb)	6 lb
FUNMER	Merivon Fungicide (55 oz)	55 oz
FUNMIL	Milstop Fungicide, 5 lb	5 lb
FUNMPE	Mpede Fungicide	2.5gal
FUNPAG	Pageant Intrinsic Fungicide	1 lb
FUNPE	Penncozeb Fungicide (30 lb) (Manzate)	30 lb
FUNPRE	Presidio Fungicide (1 qt)	1 qt
FUNPREV	Previcur Flex Fungicide (2.5 gal)	1 qt
FUNPRI	Pristine Fungicide (7.5 lb)	7.5 lb
FUNPRO	Procure 480 SC Fungicide (1 qt)	1 qt
FUNQUA	Quadris Fungicide	1 gal
FUNQUI	Quintec Fungicide (30 oz)	30 oz
FUNRAL	Rally 40 WSP Fungicide (20 oz)	20 oz
FUNRAN	Ranman Fungicide (1 qt)	1 qt
FUNREL	Reliant Fungicide (2.5 gal) (Phos-trol)	2.5 gal
FUNREG	Regalia Biofungicide (2.5 gal.)	2.5 gal
FUNRIDS	Ridomil Gold SL Fungicide (1 pt)	1 pt
FUNRY	Rhyme Fungicide (50 oz)	50 oz
FUNSOV	Sovran DG Fungicide (1.25 lb)	1.25 lb
FUNST	Stargus Fungicide (2.5 gal)	2.5 gal
FUNSUL	Sulfur Fungicide, (Yellow Jacket II)	30 lb
FUNTAN	Tanos Fungicide (7.5 lb)	7.5 lb
FUNTOP	Talaris 70 WSB Fungicide (5 lb) (Topsin)	5 lb
FUNTOR	Torino Fungicide (34 oz)	34 oz
FUNVI	Vivando Fungicide, (1 gal)	1 gal
FUNZAM	Zampro Fungicide (140 oz)	140 oz
FUNZIR40	Ziram 76 DF Fungicide (40 lb)	40 lb

Irrigation Supplies

Sprinklers

This medium volume sprinkler gun is suitable for use in general field irrigation on solid set travelers, center pivots, etc. Changing from part circle to full circle operation is easy by adjusting trip stops. Komet #163 shows good performance on windy conditions. We also carry some common parts for the Komet gun.



4 Leg Stand for Komet Gun



Komet #163

ITEM #	DESCRIPTION	PRICE
KOM163	Komet Gun	\$194.45
KOMDR	Drive Nozzle	\$5.72
KOMN6	Nozzle Holder	\$4.52
KOMNO	#8 - #16 Nozzle	\$6.48
GSO154	Leg Stand for Komet Gun	149.74

Nozzle PSI	31 8mm GPM/DIA	39 10mm GPM/DIA	47 12mm GPM/DIA	55 14mm GPM/DIA	63 16mm GPM/DIA
40	26/141	35/154	47/167	61/175	77/182
50	29/151	39/165	53/179	68/188	86/187
60	32/159	43/177	58/190	75/200	94/210
70	34/155	46/185	62/198	81/205	101/218
80	36/73	50/193	67/208	87/216	109/224

Mini Wobbler

ITEM #	DESCRIPTION	PRICE
SENWOB200	Upright Mini Wobbler Body Only	3.12
SENWOB250	Inverted Mini Wobbler Body Only	3.12



	Nozzle Pressure (psi)				
	20	25	30	35	40
#4 Nozzle - Light Blue 1/16"					
Flow (gpm)	.50	.56	.62	.68	.72
Diameter at 1.5' height	28.0	29.2	30.0	30.4	30.8
#5 Nozzle - Beige 5/64"					
Flow (gpm)	.75	.84	.91	.99	1.06
Diameter at 1.5' height	33.6	34.8	35.6	36.0	36.4
#6 Nozzle - Gold 3/32"					
Flow (gpm)	1.10	1.25	1.36	1.47	1.58
Diameter at 1.5' height	36.0	36.8	37.2	37.6	38.0
#7 Nozzle - Lime 7/64"					
Flow (gpm)	1.51	1.69	1.86	2.01	2.14
Diameter at 1.5' height	37.6	38.4	38.8	39.0	39.2
#8 Nozzle - Lavender 1/8"					
Flow (gpm)	1.95	2.18	2.39	2.61	2.78
Diameter at 1.5' height	38.4	38.8	39.2	39.4	39.6

Wobbler

The Wobbler, first introduced in 1980, uses Senninger's off-center rotary-action technology, which provides extremely uniform coverage over a large diameter at low-pressures. It produces droplets that resist wind-drift and are applied in a gentle rain-like pattern. The Wobbler is constructed entirely of engineering grade thermoplastics for excellent corrosion resistance and is extremely durable due to having only one moving part.

ITEM #	DESCRIPTION	PRICE
SENWOB00B2	Upright Wobbler Body Only	7.86

PSI	GOLD #6 3/32"		LAVENDER #8 1/8"		TEAL #310 5/32"		RED #12 /16"		BLUE #14 7/32"		ORANGE #16 1/4"	
	GPM	DIA	GPM	DIA	GPM	DIA	GPM	DIA	GPM	DIA	GPM	DIA
10	.77	37.5	1.44	41.0	2.26	42.8	3.23	44.2	4.34	45.4	5.61	46.2
20	1.08	45.7	2.02	48.2	3.18	49.4	4.54	50.4	6.11	51.2	7.88	51.9
30	1.31	46.2	2.48	48.8	3.90	50.3	5.55	51.4	7.46	52.2	9.63	52.8
40	1.50	46.4	2.82	49.2	4.45	50.8	5.85	51.8	8.53	52.6	11.01	53.2



Standard angle

Low angle

Inverted Mister

The patented Senninger Mister's innovative built-in check valve design prevents damage to plant material below due to drainage immediately following each irrigation session. It also helps to assure water conservation and consistent system start-up delivering an instantaneous, highly uniform distribution ideal for short-cycle applications.

Features

- Outstanding uniformity
- Bridge-less design for uninterrupted
- 360° pattern
- Easy to clean nozzle and optional check valve, quick twist tool-free disassembly
- Multiple connection options to retrofit existing systems
- Color-coded nozzles
- Engineering-grade UV-resistant thermoplastic construction



Pressure	30-50 psi
Light Blue - MRI08	7.5 - 9.7 gph
Head Spacing	2 - 4 ft
Lateral Spacing	2 - 4 ft
Single Row Spacing	2 - 3.5 ft
Blue - MRI12	12.5 - 16.2 gph
Head Spacing	2 - 4 ft
Lateral Spacing	2 - 4 ft
Single Row Spacing	2 - 3 ft
Purple - MRI16	15.9 - 20.5 gph
Head Spacing	2 - 4 ft
Lateral Spacing	2 - 4 ft
Single Row Spacing	2 - 3 ft
Black - MRI20	17.8 - 23.4 gph
Head Spacing	2 - 4 ft
Lateral Spacing	2 - 4 ft
Single Row Spacing	2 - 3 ft

ITEM #	PRICE
SENMI08	3.65
SENMI12	3.65
SENMI16	3.65
SENMI20	3.65

High Angle Smooth Drive Sprinkler

Senninger's new Smooth Drive's unique walking diffuser helps deliver an extremely uniform pattern, without distortion from bracket legs.

Features

- Low Angle (LA) model is ideal for under trees
- High Angle (HA) model for open field
- Walking diffuser - for outstanding
- uniformity, no bracket-leg shadow and gentle application
- Precision-contoured deflector - provides greater throw and enhanced distribution
- Advanced braking mechanism - for smooth, consistent rotation speed and minimal riser stress
- Rugged design - stands up in harsh field conditions



Nozzle PSI	#6 3/32"	#7 7/64"	#8 1/8"
	GPM/DIA	GPM/DIA	GPM/DIA
25	1.22/62	1.68/63	2.21/65
30	1.34/65	1.84/67	2.42/68
35	1.45/67	1.99/68	2.62/69
40	1.55/68	2.12/69	2.79/71

ITEM #	PRICE
SENSD5	9.85

All T Sprays

The Senninger T-Spray delivers a fine spray - ideal for delicate stock. It can be mounted upright or inverted and is also available in a high angle model for upright installations only.

Features

- 360° Spray nozzle.
- No moving parts for longer life
- High-angle upright T-stem provides larger diameter of coverage
- Color-coded stems for easy size identification



ITEM #	PRICE
SENTS06	2.38
SENTS07	2.38
SENTS08	2.38

Nozzle PSI	#6 3/32"	#7 7/64"	#8 1/8"
	GPM/DIA	GPM/DIA	GPM/DIA
15	.98/15.5	1.34/17	1.73/18.0
20	1.14/17	1.56/18.5	2.01/19.5
25	1.27/18	1.73/19.5	2.23/20.5
30	1.40/19	1.90/20.5	2.45/21.0

Senninger 4123

Senninger's Part-Circle sprinklers are designed specifically for use where a directional impact sprinkler is required. Engineered to deliver maximum efficiency at low to moderate flow rates for agriculture, nursery, effluent disposal, dust suppression, and industrial applications. Reach diameter based on 1.5 height.

Features

- Distributes water in a 60° - 360° adjustable pattern in 5° increments, no tools needed
- Easily convertible to full-circle operation
- Covered reversing mechanism
- Wide range of nozzle and vane combinations for excellent distribution at all pressures
- Inlet size: 3/4" M NPT
- Flow range: 2.42 to 16.10 gpm (550 to 3657 L/hr)



Senninger
Irrigation Inc.

Nozzle	#8	#9	#10
PSI	1/8"	9/64"	5/32"
	GPM/DIA	GPM/DIA	GPM/DIA
30	2.42/38	3.08/40	3.82/41
35	2.62/39	3.33/41	4.13/43
40	2.79/40	3.56/42	4.41/44
45	2.97/41	3.78/43	4.68/45
50	3.28/42	3.98/43	4.93/46

ITEM #	DESCRIPTION	PRICE
SEN4123PC	3/4" Partial Circle Impact Sprinkler	26.36

Senninger 5023-2

The 50 Series full-circle impacts handle the highest flow rates for Senninger's 3/4" sprinklers. The chart below shows the GPM/DIA with the #8 spreader nozzle attached to the standard nozzles. Reach diameter is based on a 1.5 ft height.



ITEM #	DESCRIPTION	PRICE
SEN5023-2	3/4" MPT Full Circle Impact Sprinkler	14.22

Nozzle	#13 x #8	#14 x #8	#15 x #8	#16 x #8	#17 x #8	#18 x #8
PSI	13/64"	7/32"	15/64"	1/4"	17/64"	9/32"
	GPM/DIA	GPM/DIA	GPM/DIA	GPM/DIA	GPM/DIA	GPM/DIA
30	8.23/99	9.35/94	10.3/96	11.5/98	12.5/99	13.7/100
35	8.88/95	10.1/98	11.2/100	12.4/102	13.5/104	14.8/105
40	9.5/98	10.8/101	11.9/103	13.3/105	14.4/107	15.8/109
45	10.1/100	11.5/103	12.7/106	14.1/108	15.3/110	16.7/112
50	10.6/102	12.1/105	13.4/107	14.8/109	16.1/111	17.6/113
55	11.1/103	12.7/106	14.0/108	15.5/110	16.9/112	18.5/114
60	11.6/104	13.2/107	14.6/109	16.2/111	17.7/122	19.3/115

Senninger
Irrigation Inc.

Upright Mister

Designed for propagation or low volume misting applications!

Features

- Outstanding uniformity
- Bridge-less design for uninterrupted
- 360° pattern
- Easy to clean nozzle and optional check valve, quick twist tool-free disassembly
- Multiple connection options to retrofit existing systems
- Color-coded nozzles
- Engineering-grade UV-resistant thermoplastic construction



ITEM #	DESCRIPTION	PRICE
SENMU08	Red Upright Mister 6.8 - 8.6 gph	2.48
SENMU12	Orange Upright Mister 10.8 - 14 gph	2.48
SENMU16	Yellow Upright Mister 14.1 - 18.3 gph	2.48
SENMU20	Green Upright Mister 17.8 - 23.4 gph	2.48

Senninger
Irrigation Inc.

Upright Recommended Spacing at 12 in. above crop

Pressure	30-50 psi
Red - MR08	6.8 - 8.6 gph
Head Spacing	2 - 4 ft
Lateral Spacing	2 - 4 ft
Single Row Spacing	2 - 3.5 ft
Orange - MR12	10.8 - 14.0 gph
Head Spacing	2 - 4 ft
Lateral Spacing	2 - 4 ft
Single Row Spacing	2 - 3 ft
Yellow - MR16	14.1 - 18.3 gph
Head Spacing	2 - 4 ft
Lateral Spacing	2 - 4 ft
Single Row Spacing	2 - 3 ft
Green - MR20	17.8 - 23.4 gph
Head Spacing	2 - 4 ft
Lateral Spacing	2 - 4 ft
Single Row Spacing	2 - 3 ft

Pressure Regulators

Pressure regulators are recommended for all drip irrigation systems. If no pressure regulators are used high pressure surges or high pressure operation can cause damage to drip tape. Regulators should be installed close to the field being irrigated. The 1.5" regulators have springs to maintain a constant pressure. These springs can be changed to change the pressure. NOTE: Flow rate on all regulators must be matched to your drip irrigation system or field size. These pressure regulators are flow activated, water must be flowing through to make them work.

PRO71

FHTXMH5, 3/4", 0.1-8

ITEM #	SIZE	PSI	GPM	PRICE
PRO71	3/4"	15	0.1-8	\$10.05



PRO720

ITEM #	SIZE	PSI	GPM	PRICE
PRO715	3/4"	15	0.1-8	\$10.65
PRO720	3/4"	20	0.1-8	\$10.65
PRO735	3/4"	35	0.1-8	\$10.65



PR1015

ITEM #	SIZE	PSI	GPM	PRICE
PRO1015	1"	15	2-20	\$14.42
PRO1020	1"	20	2-20	\$14.42



PR1515

Netafim Regulator

ITEM #	SIZE	PSI	GPM	PRICE
PR1515	1 1/2"	15	10-40	42.15
PR1520	1 1/2"	20	10-40	42.15



Ultra High Flow Pressure Regulator

Introducing Senninger's New Ultra High Flow Pressure Regulator

The PRU (Pressure Regulator Ultra) is designed to maintain a preset pressure for higher flows of 20 to 100 gpm (4542 to 22713 L/hr). The compact size makes it convenient for use in a valve box. Its 2-inch inlet and outlet size make it an ideal option for accurate zone and individual sprinkler pressure control. One PRU can be used in place of a manifold of multiple smaller regulators. Reliable: Accuracy and quality you can count on with Senninger pressure regulators, Convenient: Compact size fits in a valve box, Economical: Competitively Priced



ITEM #	SIZE	PSI	GPM	PRICE
PR2115	2"	15	20-100	114.53
PR2120	1"	20	20-100	114.53
PR2135	2"	30	20-100	114.53

Garden Drip Kit

Garden Drip Irrigation Kit (20 rows)

This is a complete garden irrigation kit in a box. It has everything you need to set up your garden up to 20 rows 50' long or a total of 1,000' of row length.

Kit includes;

- 1- Roll of Chapin 6" Drip Tape 1000'
- 1- Roll of 3/4" x 100' Orchard Tubing (55 PSI)
- 20- Drip Tape Valve w/Green Handle .250 Barb Fitting
- 20- Drip End Sleeves
- 6- Yellow Drip Coupling w/clear lock nuts Fitting
- 1- Pack of Goof Plugs 1/8"- 1/4" Holes (Pack of 10)
- 1- 1/8"-1/4" Economy Punch
- 1- 3/4 Dig Filter w/Regulator Fht x Mht assembly
- 1- 3/4" Power-loc x Fht Fitting
- 1- 3/4" Power-loc End Cap Fitting

ITEM #	PRICE
GARDRK	\$125.91

V-Rain Sprinkler

Full circle standard trajectory angle for maximum throw. Built from brass construction, excellent for many types of fields. Common spacing 60'x60' or 30'x50'.



V-Rain 75-27

ITEM #	DESCRIPTION	PRICE
RB30H	V-Rain Sprinklers w/9/64 Nozzle	22.09

NOZ PSI	Nozzle 9/64" x 3/32" 7° GPM DIA.		NOZZLE 5/32" X 3/32" 7° GPM DIA		NOZZLE 11/64" X 3/32" 7° GPM DIA.		NOZZLE 3/16" X 3/32" 7° GPM DIA		NOZZLE 3/16" X 1/8" 20° GPM DIA		NOZZLE 3/64" X 1/8" 20° GPM DIA		NOZZLE 7/32" X 1/8" 20° GPM DIA	
25	4.18	80	4.83	83	5.55	83	6.31	85	7.40	85	8.30	86	9.25	88
30	4.58	81	5.28	85	6.07	88	6.93	91	8.15	91	9.15	94	10.20	96
35	4.95	82	5.71	87	6.57	90	7.51	94	8.83	94	9.93	97	11.10	100
40	5.29	83	6.11	88	7.03	92	8.03	96	9.46	96	10.65	99	11.90	102
45	5.61	84	6.48	89	7.46	94	8.53	98	10.05	98	11.30	101	12.65	104
50	5.91	85	6.82	90	7.87	95	9.00	100	10.60	100	11.90	103	13.35	106
55	6.20	86	7.15	91	8.25	96	9.45	101	11.10	101	12.50	104	14.00	107
60	6.48	87	7.47	92	8.6	97	9.86	102	11.60	102	13.00	105	14.50	108
65	6.75	88	7.78	93	8.93	98	10.27	103	12.10	103	13.50	106	15.00	109
70	7.00	89	8.08	94	9.25	99	10.66	104	12.50	104	14.00	107	15.45	110
75	7.50	90	8.37	9	5	9.56	100	11.02	105	12.90	105	14.40	108	111
80	7.49	91	8.65	96	9.87	101	11.36	106	13.25	106	14.80	109	16.30	112

LARGE ANNUAL PLUG, GREENHOUSE & PRODUCE EQUIPMENT AUCTION

Saturday, March 1st 2025 @ 9:00 A.M.

AUCTION HELD AT SHIPPENSBURG AUCTION CENTER, 1120 Ritner Hwy Shippensburg, PA 17257, Approx 1 mile North of Shippensburg on RT. 11 / ac From Rt. 81 take King St. Exit 29, go West on Et. 174 at light, turn R, on Coorestuga Rd, then right on Et. 11 to Sale on right

Top Quality Plug Auction

Large Variety of vegetative, & seed animals, perennials, succulents, vegetables, herbs & much more; Expecting approx. 3,000 trays;

New & used supplies, Always a nice line of gloves, tape, dry line, seeds, valves, Liners, knives, sprayers, drip tape, ½" plastic irrigation tubing & more;

Plastic layer, sprayers; water wheel trans planters, pumps;

Call with consigned items 1 month before Auction for best advertising;

No Consignments Day of Auction unless prior arrangements are made;

AUCTIONEERS NOTE: Bring a friend selling plugs w/ 2 auctioneers; Plugs start @ 9:00 AM Sharp; Selling w/ 3rd auctioneer on produce & greenhouse equipment & supplies;

ATTENTION PLUG CONSIGNEERS: We must know beforehand the amount of plugs you want to consign; Please contact Lary

Auction Coordinator: Larry Burkholder 717-532-2070

Darryl Jones AU5194 717-226-8776 or 717-776-9498
Jason Brubacker AU5608 717-729-0173



Performance Table

Nozzle Color	Anti-mist Color	Flow Rate [GPH]	Nozzle Ø [inch]	Wetted Diameter (feet)																		
				Static Spreaders						Swivels												
				90° (Black)	180° (Red)	Mist (Violet)	Strip (Blue)	Close-Range (Orange)	Flat (Yellow)	12 Jet (Green)	Small (Black)	Anti-Ant (Red/Black)	One-Sided (Black)	One-Sided (Blue)	Big (Orange)	Inverted* (Green)	Height (feet)					
Violet		9.2	0.032	5.6	7.2	4.9	10.5	3.0	9.2	11.2	19.7	19.7	21.3							16.4	19.7	19.7
Brown		11.4	0.037	5.6	8.2	5.9	13.8	3.0	11.2	14.8	19.7	21.3	23.0							18.0	19.7	21.3
Grey		18.5	0.046	8.2	8.9		27.9	3.0	11.2	18.0	21.3	21.3	24.6							21.3	21.3	24.6
Green		27.7	0.056	11.5	8.9		29.5	3.0	11.2	19.7	21.3	23.0	26.2			29.5	26.2	26.2	27.9	29.5	26.2	27.9
Orange		31.7	0.059	14.8	8.9		29.5	3.0	13.1	19.7	21.3	24.6	26.2			29.5	26.2	27.9	29.5	29.5	26.2	29.5
Yellow		42.3	0.068								21.3	26.2	27.9	26.2	31.2	29.5	29.5	31.2	29.5	29.5	31.2	29.5
Blue		52.8	0.076									27.9	29.5	27.9	31.2	29.5	29.5	31.2	29.5	29.5	31.2	32.8
Ivory		62.1	0.081										31.2	29.5	32.8	29.5	31.2	34.4	29.5	31.2	34.4	31.2
Red		68.7	0.086										32.8	32.8	32.8	29.5	32.8	36.1	29.5	32.8	36.1	36.1
Black		79.3	0.092										34.4	34.4	32.8	31.2	32.8	36.1	31.2	32.8	36.1	36.1
Green	Green	10.6	0.037	6.6	3.9		9.2	2.6	11.5	8.2	13.1									14.8	16.4	19.7
Orange	Orange	18.5	0.046	7.2	7.2		16.4	2.6	11.5	14.8	16.4									19.7	23.0	24.6
Yellow	Yellow	23.8	0.055	8.2	8.2		18.0	3.0	13.1	16.4	18.0									19.7	23.0	26.2
Blue	Blue	31.7	0.059	8.2	8.9		23.0	3.3	13.1	19.7	19.7									21.3	26.2	26.2

DAN Modular Micro Sprinkler

Dan Modular is the original micro-sprinkler that set the standard for all micro-sprinklers. The broad range of flow rates, wetted diameters and patterns from full to part circle with different sprayers, swivels, and anti-mist devices that produces small, medium, and large droplets makes it practically a universal device for agriculture, greenhouse, and landscape applications. For over two decades Dan Modular has been the product of choice as a standard micro-sprinkler for greenhouse applications.



Product Features

- Dan Modular design offers comprehensive flexibility in an irrigation design
- Adapts to almost any field condition
- Broad range of flow rates, 10 nozzles and 4 anti-mist devices produce 14 flow rates from:
 - 9.2 to 79.3 GPH @ 29 psi
 - 7 static spreaders and 5 swivels produce a wide variety of patterns and diameters
 - Provides a range of desired droplet sizes from fog to mist to large droplets
 - Field friendly, may be assembled and disassembled in the field
 - Under-tree and over-tree, irrigation, frost protection and cooling (including chilling)
 - Upright for field and greenhouse applications
 - Inverted for greenhouse and hoop house applications
 - Compatible with Leak Prevention Device (LPD)
- Recommended filtration 120 mesh
- Made of durable plastic for long term field operations – high UV resistance
- Nozzles are manufactured from wear resistant materials
- Clog resistant due to large water passages
- Even and uniform distribution of water and fertilizers

Technical Data

- Flow rates: 9.2 to 79.3 GPH @ 29 psi
- Recommended working pressure: 15 to 53 psi
- Required filtration: 120 mesh
- Wetted diameter: 8 to 35 feet

The following pages contain the technical information about the DAN Modular system.

By NaanDanJain Irrigation



ITEM #	DESCRIPTION	PRICE	100+	1000+
A NGEF1	Female Adapter for Pc Dripper-1/8 Tubing	0.2		
B NGEF2	2-Way Manifold	0.46	\$0.44	
C NGEF3	Stackable 2-Way Manifold - Open End	\$0.35	\$0.32	
D NGEF4	Stackable 4-way Manifold - Open End	\$0.43	\$0.39	
E NGEF5	Flat 4-way Manifold	\$0.43	\$0.39	
F NMD8	2 GPH 8 Outlet MOD	1.59	\$1.43	
G NMD83	Angled 4" Dripper Stake, .69 GPH Flow Rate	0.28		\$0.25
G NMD82	Straight 3" Dripper Stake, .69 GPH Flo Rate	0.28		\$0.25
H NMS1	Agri-Connector 1/2" Fpt x 3/16" Barb	1.81		
I NMS314	12" Plastic Stake	1.19		
J NMS35	1/2" Mpt Base for Micro	1.29		
K NMS3	Bridge for Micro-Sprinkler	0.99		

Nozzles for Micro Irrigation



ITEM #	FOR MICRO	GPH	PRICE
NMS024	Brown Nozzle	11.4	0.49
NMS032	Violet Nozzle	9.2	0.49
NMS055	Green Nozzle	27.7	0.49
NMS060	Orange Nozzle	31.7	0.49
NMS067	Yellow Nozzle	42.3	0.49
NMS075	Blue Nozzle	52.8	0.49

Spinners and Spreaders



ITEM #	FOR MICRO	PRICE
NMS40	Black Single Wing Spinner	0.68
NMS41	Black Round Spinner	0.68
NMS42	Green Kiwi Spinner	0.68
NMS43	Orange Oblong Spinner	0.68
NMS51	Purple Spreader	0.38
NMS52	Yellow Flat Spreader	0.38

FOGGERS AND ACCESS

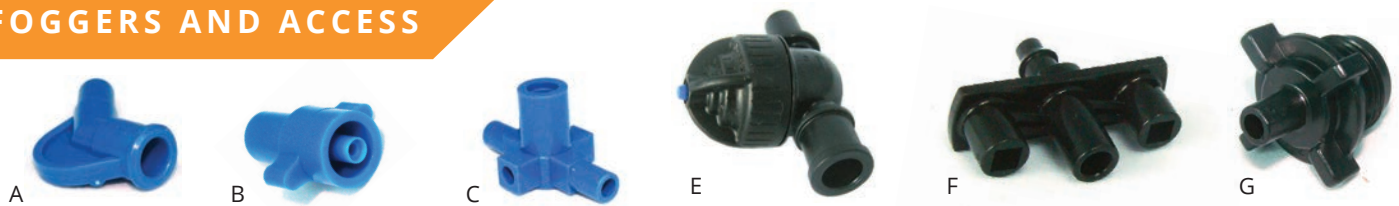

ITEM #	DESCRIPTION	PRICE
A NMF45	45 Degree Angle for Fogger	0.95
B NMFP	Plug for Fogger	0.64
C NMFT	2-Way Tee for Fogger	1.43
D NMFX	4 way Cross for Fogger	1.57
E NMS2	High Pressure L.P.D (Anti-Drip) (Blue)	2.74
E NMS2L	Low Pressure L.P.D (Anti-Drip) (Black)	2.64
F NMS33	Butterfly Mount for Micro	0.89
G NMS35	1/2" Mpt Base for Micro	1.29

DAN Foggers

For cooling and humidification in greenhouses. Contact us for design and application information.



ITEM #	DESCRIPTION	GPH	PRICE
NMF018	Blue Foggers (1.8 gph)	1.8	1.43
NMF036	Orange Foggers (3.6 gph)	3.6	1.43
NMF054	Red Foggers	5.4	\$0.95
NMF072	Black Foggers (7.2 gph)	7.2	1.43

Coupling for Spaghetti Tubing



ITEM #	SIZE	PRICE
TB125	1/8"	0.19
TB250	1/4"	0.24

PVC Sprinkler Stands

ITEM #	SIZE	PRICE
PVCS007	3/4"	19.88
PVCS020	2"	29.53



Aqua Spray Sticks

Aqua Spray Sticks are engineered to provide an irrigation system that delivers both high performance and dependability. Features dual shut off capability, spray direction indicator, down spray and horizontal spray patterns.



ITEM #	FLOW	GPH	PSI	PRICE	100+
ASSD4.2	Mini	4.2	20	0.58	\$0.57
ASSD6.6	Low	6.6	20	0.58	\$0.57
ASSD6.6	Low	6.6	20	0.58	\$0.57
ASSF10.8	Med	10.8	20	0.58	\$0.57
ASSF3.0	Mini	3.0	20	0.58	\$0.57

Dramm Hozon Syphon Mixer

The syphonject draws a concentrated solution from a bucket through a flexible suction tube. The solution is then diluted as it enters the water stream at an approximate ratio of 20 parts water to one part concentrated solution. Requirements: A full flow nozzle 3-5 GPM., Minimum water pressure at faucet 35 PSI, max hose length of 50', any restrictions in the line downstream will cause backpressure and it will not work.



ITEM #	PRICE
GGA200	15.61

Pre-assembled 4-way Spider

ITEM #	SIZE	PRICE
NGE18	18"	1.7
NGE24	24"	1.85
NGE30	32"	1.9
NGE36	36"	1.95



Stabilizing Hanging Tubes

Stabilized Hanging Tubes Includes 3/16" tube w/barb on one end and a butterfly mount on the other with weight.



ITEM #	SIZE	PRICE
NMS24	24"	2.72
NMS36	36"	2.94
NMS48	48"	2.89

Irrigation Field Stand Assembly

This irrigation stand is a very easy and economical way of irrigating long rows of produce. To install, first lay the orchard tube, then punch a hole in orchard tubing at predetermined sprinkler location, insert fitting from assembly, pound in 5/16" steel rod or PVC pipe and attach agri connector to stake. At the end of season it is very easy to disassemble and store for the winter.



ITEM #	DESCRIPTION	PRICE
FIESTR24	24" Irrigation Field Stand Steel Rod	2
FIESTR48	48" Irrigation Field Stand Steel Rod	3
SENFiesta48	48" Field Stand Assembly W/ Super Barb	3.36

Parts for the field stands

ITEM #	DESCRIPTION	PRICE
SENFiestB	Super Barb Winged Bushing (#3 Male Taper)	0.75
SENFiestSBF	Super Barb Fitting (#3 Male Taper)	0.5
SENFiestSBP	Super Barb Fitting Plug (#3 Male Taper)	0.5

Controllers

DC Irrigation Controller

Features

- Operate one valve or up to four stations with sensor and master valve (four station) without AC power hookup
- Four button keypad with an integrated LCD display
- Easy to read AM/PM clock
- Independent programming for each valve (four station)
- Can operate two valves simultaneously (four station)
- Digital icon indicates station in operation (four station)
- Automatic, semi-automatic and manual operation
- Operates with R710DC latching solenoids
- Irrigation suspension override (rain mode)
- Master valve wires included with the four station model
- Withstand harsh climatic conditions - rated IP68, the highest attainable code classifying the degree of protection against water intrusion (completely sealed and waterproof)
- Mount to valve or valve box wall
- Powered by one 9-volt alkaline battery (not included) featuring low power consumption
- Program stored for up to 20 seconds during battery change
- Single station includes the solenoid



ITEM #	DESCRIPTION	PRICE
DG540	DC 4 Station Controller	115.92
DG560	DC 6 Station Controller	124.27
DG710	DC Single Station Controller	99.92

DC Valve

In-line Valve Features

- Internal bleed, does not have manual override for manual ON/OFF
- High flow with low pressure loss
- Rugged, reinforced self-cleaning diaphragm provides reliable operation even with contaminated water
- Flow control handle for water flow adjustment and manual shutoff
- FPT inlet x FPT outlet, 10 - 150 operating pressure

ITEM #	DESCRIPTION	PRICE
DG007	6 - 9 VOLT DC VALVES 3/4"	47.4
DG010	6 - 9 VOLT DC VALVES 1"	48.05
DG015	6 - 9 VOLT DC VALVES 1.5"	107.38
DG020	6 - 9 VOLT DC VALVES 2"	114.66
DCSOL	2 Wire New Style DC Solenoid Only	20.8
DCSOL3	3 Wire Old Style DC Solenoid Only	31.3

AC 4 Station Controller

The Orbit 4-station swing door timer comes in a weatherproof cabinet with internal transformer for easy indoor or outdoor plug-and-go installation. Easy-Set Logic provides for headache-free programming.



Features and Benefits

- Indoor/Outdoor Mounting
- Easy-Set Programming Logic
- 3 Programs for flexible scheduling
- Large LCD and Dial

ITEM #	DESCRIPTION	PRICE
ORBAC4	AC 4 Station Controller	68.61

24 Volt AC Valve

In-line Valve Features

- Internal bleed, manual override for manual ON/OFF
- High flow with low pressure loss
- Rugged, reinforced self-cleaning diaphragm provides reliable operation even with contaminated water
- Flow control handle for water flow adjustment and manual shutoff
- Fipt, 10 - 150 PSI



ITEM #	DESCRIPTION	PRICE
EV007	AC 3/4" DIG VALVE	23.58
EV010	AC 1" DIG VALVE	31.44
EV015	1 1/2" • 20 - 140	\$96.00
ACSOL	AC Solenoid Only	16.71



DC Battery Valves and Controllers

DC Propagation Controllers

Heavy duty plastic with DC latching solenoid for above controllers. All have FPT connections and operate at 10 to 150 PSI, have manual flow control valve and are normally closed.



ITEM #	DESCRIPTION	PRICE
DG71010P	DC Propagation Controller w/1" Valve	126.65
DG71075P	DC Propagation Controller w/3/4" Valve	118.19
DG710AP	Single Station Propagation Controller	107.23

Single Station w/ Valve

Completely waterproof, the 700 series has a long list of features, including 4 start times per valve per day water budget, AM/PM clock, watering duration from 1 minute to 12 hours, 7 day programming options, simple 4 button design and easy to read screen. Sleek and compact, the 700 series are only 4 1/4" H x 5" L x 3 1/2" W. Can be used to temperatures from 38 to 130. Uses AA batteries.



When ordering valves, please provide model # of your controller.

ITEM #	SIZE	PRICE
DG71075	3/4"	104.69
DG71010	1"	117.15
DG71015	1.5"	178.71
DG71020	2"	193.34

Garden Hose Controllers

Battery operated (9 volt battery) with FHT inlet and MHT outlet. 10-140 PSI. max flow is 5.2 GPM. Has 6 buttons.



ITEM #	DESCRIPTION	PRICE
DG9001D	Battery Op Garden Hose Controller	38.84

Pumps

Steps To Selecting a Pump

- Start with your desired PSI at the end of your line.
- Add PSI loss, use elevation conversion scale on page 109 to figure PSI loss per foot of rise
- Add friction loss per pipe type from page 110
- Add filter PSI loss, approx. 5-10 PSI
- Total would indicate what PSI you would need at the pump to irrigate

IPT Pump (6.5 HP)

IPT 2" Engine Driven Portable High Pressure pumps are cast aluminum construction with cast iron volute and male NPT ports. Pump applications include fire protection and irrigation. These pumps are available with a wide choice of standard and heavy duty gasoline or diesel fueled engines. These pumps feature high efficiency closed cast aluminum impeller. All models come equipped with EPDM/EPR elastomers and seals. Most models include a heavy duty steel roll frame.

Features

- Cast Aluminum Construction
- EPDM/EPR Mechanical Seals
- Optional Viton® Seal and Elastomers Available
- 2" Cast Iron Suction & Discharge Male NPT Port Sizes
- Maximum Flow up to 130 GPM
- Maximum Head up to 108 PSI
- Maximum Lift to 26 Ft.
- One Tool Serviceability
- Utilized for Fire Protection or Irrigation
- Discharge Port Rotates in 90° Increments
- Engine Options: Honda, Briggs & Stratton Gasoline or Hatz Diesel Engines



PUMP PERFORMANCE CHART						
GPM	125	100	75	50	25	0
PSI	0-PSI	29-PSI	48-PSI	65-PSI	76-PSI	88-PSI

ITEM #	DESCRIPTION	PRICE
PU2P5H	2" IPT Pump w/6.5HP Honda (base unit)	816.17
PU2P5G	2" IPT Pump w/6.5HP Honda w/Roll Cage	885.42
PU2P5HRC	2" IPT Pump w/6.5HP Honda Complete	999.19

9 HP Honda 2 Stage High Pressure Pump with Roll Cage

Features

- Cast Aluminum Construction with Cast Iron Diffusers
- Two-Stage Precision Cast Aluminum Impellers
- 2" NPTM Cast Iron Suction Port
- Three-Way Cast Iron Discharge Port
- Viton® Mechanical Seal with Silicon Carbide and Carbon Faces
- EPDM/EPR O-Rings and Gaskets
- Maximum Head up to 155 PSI
- Maximum Flow up to 160 GPM
- Built-in Flapper/Check Valve Permits Self-priming to 20 Ft.
- Heavy Duty Steel Roll Frame Included
- Engine Options: Honda, Briggs & Stratton Gasoline or Hatz Diesel
- Optional Wheel Kit Available

Close up view of optional 1-1/2" MNPT 2MPX-90 Flange Kit



PUMP PERFORMANCE CHART						
GPM	120	80	60	40	20	0
PSI	35-PSI	95-PSI	112-PSI	125-PSI	132-PSI	138-PSI

ITEM #	DESCRIPTION	PRICE
AMT2MP9	9 HP Honda, 2 Stage High Pressure Pump	1795

1.5", 1 HP Electric Pump, 1PH, 115/230 V

Features

- 300 Series Investment Cast Stainless Steel Construction with Viton® Seals
- Cast Iron Construction with Buna-N Seals
- Optional Silicon Carbide Seals Available
- 1-1/2" NPT Port Size
- Maximum Temperature
- Stainless Steel 200° F
- Cast Iron 180° F
- Maximum Flow 120 GPM
- Maximum Head 102 Ft. (44 PSI)
- Self-Priming up to 20 Feet with Built-in Check Valve
- Self-Cleaning, Clog Resistant Impeller
- Solids Handling and Dirty Water Design
- 1/2 to 3 HP 56j Single or Three Phase 3450 RPM Motors



PUMP PERFORMANCE CHART						
GPM	80	60	50	40	20	0
PSI	4-PSI	15-PSI	19-PSI	22-PSI	30-PSI	34-PSI

ITEM #	DESCRIPTION	PRICE
AMT1	1.5", 1 HP Electric Pump, 1PH, 115/230 V	627.94

2", 2 HP Electric Pump, 1PH, 115/230 V

Features

- 300 Series Investment Cast Stainless Steel Construction with Viton® Seals
- Cast Iron Construction with Buna-N Seals
- Optional Silicon Carbide Seals Available
- 2" NPT Port Size
- Maximum Temperature
- Stainless Steel 200° F
- Cast Iron 180° F
- Maximum Flow 150 GPM
- Maximum Head 102 Ft. (44 PSI)
- Self-Priming up to 20 Feet with Built-in Check Valve
- Self-Cleaning, Clog Resistant Impeller
- Solids Handling and Dirty Water Design
- 1-1/2 to 3 HP Single or Three Phase 3450 RPM Motors



PUMP PERFORMANCE CHART

GPM	100	80	60	40	20	0
PSI	8-PSI	15-PSI	22-PSI	28-PSI	32-PSI	36-PSI

ITEM #	DESCRIPTION	PRICE
AMT2	2", 2 HP Electric Pump, 1PH, 115/230 V	774.44

2", 3 HP Electric Pump, 1PH, 230 V

Features

- 300 Series Investment Cast Stainless Steel Construction with Viton® Seals
- Cast Iron Construction with Buna-N Seals
- Optional Silicon Carbide Seals Available
- 2" NPT Port Size
- Maximum Temperature
- Stainless Steel 200° F
- Cast Iron 180° F
- Maximum Flow 150 GPM
- Maximum Head 102 Ft. (44 PSI)
- Self-Priming up to 20 Feet with Built-in Check Valve
- Self-Cleaning, Clog Resistant Impeller
- Solids Handling and Dirty Water Design
- 1-1/2 to 3 HP Single or Three Phase 3450 RPM Motors



PUMP PERFORMANCE CHART

GPM	120	100	60	40	20	0
PSI	7-PSI	13-PSI	26-PSI	31-PSI	34-PSI	36-PSI

ITEM #	DESCRIPTION	PRICE
AMT3	2", 3 HP Electric Pump, 1PH, 230 V	799

3", 5 HP Electric Pump, 1PH, 230 V

Features

Cast Iron Construction with Stainless Steel Impeller

- Buna-N Mechanical Seal, Check Valve and O-Ring
- Optional Silicon Carbide Seal Available
- 3" NPT Suction and Discharge Ports
- Maximum Solids Handling 3/8"
- Maximum Temperature 180° F
- Maximum Flow 375 GPM
- Maximum Head 110 Ft.
- Self-Priming to 20 Ft.
- Self-Cleaning, Semi-Open Impeller
- Solids Handling and Dirty Water Design
- 3 to 7-1/2 HP TEFC, Single and Three Phase Motors
- Optional Mounting Base Available



PUMP PERFORMANCE CHART						
GPM	300	240	180	120	60	0
PSI	5-PSI	16-PSI	26-PSI	32-PSI	37-PSI	39-PSI

ITEM #	DESCRIPTION	PRICE
AMT5	3", 5 HP Electric Pump, 1PH, 230 V	1816

Water Filters

Triton® Sand Filter

The Triton II filter is the result of over 40 years of product evolution and refinement. It has set the industry standard for effectiveness, efficiency, long runs between service and providing years of dependable, low maintenance operation. The Triton II filter features a special internal design that keeps the sand bed level, ensuring even water flow and resulting in the most efficient filtration possible.

- Time-proven internal design ensures that all water receives maximum filtration for crystal clear results.
- GlasLok™ Process creates a one-piece, fiberglass-reinforced tank with a UV-resistant coating for years of dependable, corrosion-resistant service.
- Flow system design controls filtration quality and ensures maximum run times between backwashing to save you time.



ITEM #	DESCRIPTION	PRICE
TR40	40 GPM Triton Sand Filter	646.07
TR60	60 GPM Triton Sand Filter	927.63
TR100	100 GPM Triton Sand Filters	1400
TR140	140 GPM Triton Sand Filters	1995.51
TR120	2" Back Flush Valve	261.81
TR122	2" Plumbing For Back Flush Valve	49.81
TR150	#50 Sand	16
TR151	#50 Gravel	14.91

Model	Tank Dia.	Sq. Ft	Wt.	Gravel	Sand	GPM
TR40	19"	1.92	25	50	125	38
TR60	24"	3.14	39	75	250	63
TR100	30"	4.91	65	150	450	98
TR140	36"	7.06	82	275	650	141

2" or 3" Plastic Disk Filter

Disk filters are designed to clean dirty water for drip irrigation systems and handle up to 3 times more dirt and debris than screen filters, before cleaning is necessary. The design of the "disk" filter is a stack of disks pressed together. These disks have tiny grooves allow clean water to pass through. To clean the filter, remove the cover, loosen the stack of disks and wash between the disks; reassemble.



- Designed for use as a primary or secondary filter
- For use with water containing high amounts of organic or inorganic matter

ITEM #	PRICE
PDF020	131.56
PDF030	136.62

Irritec Screen Filter



ITEM #	DESCRIPTION	PRICE
DGF007	3/4" Screen Filter	8.57
DGF010	1" Screen Filter	8.93
DGF150	1-1/2" Screen Filter	38.13
DGF020	2" Screen Filter	43.65
DGFO1.5-2	O-Ring for 1.5" - 2" Dig Screen Filter	10.31
DGFO.7-1	O-Ring for 3/4" - 1" Dig Screen Filter	3.82
IRFS155	SS Screens for .75" & 1" Irritec Filters	6.93
IRFS1.5/2	SS Screens for 1.5" & 2" Irritec Filters	12.2

API Spin Clean Filters

These filters are used to clean water for drip irrigation systems. They clean well water, or relatively clean water and work especially well for filtering sand out of water. But they are not recommended for surface water containing algae. We recommend a pressure gauge on the filter inlet and outlet to determine when the filter is clogging and to avoid unnecessary cleaning. For drip irrigation tape, mesh size should not be coarser than 120 mesh. Mesh size over 175 create unnecessary filter cleaning and clogging. Filters are built from a high heat, chemical resistant glass-reinforced plastic and have a stainless steel screen. Made in USA.



ITEM #	GPM	SIZE	PRICE
PSF007	9	3/4"	22.09
PSF010	18	1"	22.67
PSF015	55	1.5"	191.12
PSF020	110	2"	237.62

Spin Clean Filter Gasket

ITEM #	DESCRIPTION	PRICE
TSFG1	Fits 3/4" - 1" Filters	\$1.62
TSFG2	Fits 1.5" - 2" Filters	\$4.43



Replacement Screens

Stainless steel spin-clean screens

ITEM #	SIZE	PRICE
RSS01	Fits 3/4" - 1"	21.15
RSS02	Fits 1.5" - 2"	126.11



Stainless Steel Filters for DIG Filters

ITEM #	SIZE	PRICE
RDS01	3/4" - 1"	10.71
RDS02	1.5"	56.98
RDS03	2"	62.46



Injectors

Automatic Injector

An Economical Way to Apply Nutrients While You Irrigate. No pump or outside power source is required. Simply use the Add-It™ & Fertilizer Caddy™ to apply the optimum rate of liquid fertilizer or additive to benefit your plants.



ITEM #	DESCRIPTION	PRICE
DG5016	Automatic Proportional Fertilizer Injector	26

Field Injectors

*Does not include stand

ITEM #	DESCRIPTION	PRICE
MIC707	3/4" Field Injector w/384	159.64
MIC710	1" Field Injector w/384	167.02
MIC015	1-1/2" Field Injector w/584	204.79
MIC020	2" Field Injector w/584	237.38
MIC030	3" Field Injector w/1078	397.96



Regulator Assembly FHT X MHT



ITEM #	DESCRIPTION	PRICE
FILREGMHT	3/4" Dig Filter w/Regulator Fht x Mht	38.57
FILREGMHT1	1" Dig Filter w/Regulator Fpt x Fpt	44.81

Mazzei Injectors

INJECTION RATE CHART GPH				
INLET	OUTLET	384	584	1078
20 PSI	10PSI	4.0	13	50
30 PSI	15 PSI	5.3	18	60
40 PSI	20PSI	7.4	20	72
50 PSI	30 PSI	5.3	19	66
MAX		10.5	25	75



Venturi injectors are a high efficiency, differential pressure injectors. The pressure difference creates a vacuum inside the body which results in suction through the suction port. These injectors are trouble free because they have no moving parts. Complete units similar to above have a brass check valve, brass gate valve, flow meter, pressure gauge, and a Mazzei injector unit with bypass, all mounted on a treated wood frame for a long life.

ITEM #	DESCRIPTION	PRICE
MICPC05	Suction Port Cap for Mazzie 384 & 584	6.83
MIC384	1/2" Mazzie Injector	46.05
MIC584	3/4" Mazzie Injector	41.53
MIC1078	1" Mazzie Injector	38.85

Rebuild Kits

ITEM #	DESCRIPTION	PRICE
MIRK2	284 & 584	16.9
MIRK4	1078	27.94



Flowmeter

The direct reading scales are hot stamped into the plastic and will not wear off. Accuracy is ±5% of full scale for VFA models, scales average 2" long. Scales are easy to read - The front scale location and white background provides excellent visibility.



ITEM #	DESCRIPTION	PRICE
FLO040	1/4" Flo-meter 8-40 Gph	39
FLO100	Flo-meter 0-100 Gph - 3/8"	60.56

Suction Strainer

ITEM #	DESCRIPTION	PRICE
MICS84	1/4 in. Suction Strainer	16.64



Air Release Valve

Put in the highest point of the main line to help protect your fertilizer injectors from damage. Every drip tape system should have one of these in the highest point of the system to prevent drip tape from suctioning in dirty water when you shut off the water. If you shut off the water the lowest areas of a line are going to drain and the higher points are going to create a vacuum and try and suction in dirty water. These will prevent that and allow clean air to enter your tape instead of dirty water coming in through the drip tape slits.



ITEM #	DESCRIPTION	PRICE
APRV1	Air/Vacuum Release Valve 1" Mipt	7.75

Irrigation System Fittings

.250 Barb to Drip Tape

Black body with green lock nuts .250 barb



ITEM #	PRICE	50+
DTF250B	0.45	\$0.55

Oval Hose to Drip Tape

.40" Barb x drip tape. Black body with green lock nuts

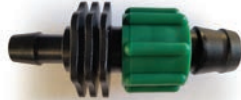

ITEM #	PRICE	50+
DTF400B	0.49	\$0.52

DTFA8

We are offering the fitting DTFP6A with a defective valve which can be used just like the A8 and has a rubber washer. Just use the DTFA8 code



ITEM #	PRICE	100+	1000+
DTFA8	0.25	\$0.20	\$0.15

DTF250BV

Drip tape fitting to go from oval hose to drip tape with a valve with a .250 barb.



ITEM #	PRICE	50+
DTF250BV	1.68	\$1.74

DTF420BV

Drip tape fitting to go from oval hose to drip tape with a valve with a .420 barb.



ITEM #	PRICE	50+
DTF420BV	1.61	\$1.73

DTF420BVR

Drip tape fitting to go from oval hose to drip tape with a valve with a .420 barb.



ITEM #	PRICE	50+
DTF420BVR	\$1.88	\$1.73

Drip Tape Tee



ITEM #	PRICE
DTFTEE	1.72

DTFH13

Lay-flat to drip tape connector
Use the punch DTFHP2 for this fitting



ITEM #	PRICE
DTFH13	1.05

DTFCPT

5/8" Repair drip coupler to repair punctured or damaged drip tape.



ITEM #	PRICE
DTFCPT	0.5

DTFP6A

Flat tube x drip line with valve



ITEM #	PRICE
DTFP6A	1.48

DTFB005

Layflat x .5" FPT/.75" MPT Connector



ITEM #	PRICE
DTFB005	1.11

DTFCT2

5/8" Repair drip coupler to repair punctured or damaged drip tape.



ITEM #	PRICE
DTFCT2	0.25

Lay-flat to Drip Tape w/ Valve



ITEM #	PRICE
DTFD3	2.25

Oval Hose Goof Plugs

Plugs 1/8"-1/4" holes 10/Pack



ITEM #	PRICE
OTMP1	0.97

Oval Hose Goof Plugs

Plugs .420 holes (gray)



ITEM #	PRICE	50+
DTFB16	0.35	\$0.40

Drip Tape Coupling w/ Valve



ITEM #	PRICE
DTCPTBV	1.68

Lay-flat Goof Plug



ITEM #	PRICE
DTFB24	1.25

FHT to Drip Tape w/ Swivel Adapter



ITEM #	PRICE
DTFHS	1.62

Drip Tape Elbow



ITEM #	PRICE
DTFELL	1.7

Drip Tape to MPT Adapter



ITEM #	PRICE
DTF75	0.97

Drip Tape Auto Flush Valve



ITEM #	PRICE
DTFG12	1.77

Drip Tape End Sleeve

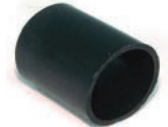

ITEM #	DESCRIPTION	PRICE
DTFCAP	Drip End Sleeves	0.09

Drip Tape Plug w/ Finger Ring



ITEM #	PRICE	50+
DTFPLUG	0.7	\$0.70

Hole Punches

Hose Punch

Oval Hose & Orchard Tubing Punches.



ITEM #	DESCRIPTION	PRICE
DTFDPT	1/8"-1/4" Economy Punch	2.15

Replacement Tip for OTFDPTB Punch



ITEM #	DESCRIPTION	PRICE
DTFAPT01	Replacement Tip For .250 Punches	4.99
DTFAPT02	Replacement Tip For .420 Punches	4.99

Orchard Tubing Punch



ITEM #	DESCRIPTION	PRICE
OTFDPTB	EZ Punch With Tip For .100" Hole	27.82

Ejector Style Punch



ITEM #	DESCRIPTION	PRICE
DTFAP03	Punch For .250 Tape Fittings & 1/4" Barbs	10.41
DTFAP07	Punch For .420 Tape Fittings	10.41

Replacement Tip for DTFAP Punch



ITEM #	DESCRIPTION	PRICE
OTFDPRB	EZ Blue Replacement tip, .100" Hole	7.97
OTFDPRBG	EZ Green Replacement tip, .150" Hole	7.97

Lay Flat Punches



ITEM #	DESCRIPTION	PRICE
DTFFHP2	Layflat Punch 19MM For DTFH13 Only	80
DTFFHP1	Layflat Punches 14MM	80

Deluxe Serrated Cutting Punch



ITEM #	DESCRIPTION	PRICE
DTFDP400S	Serrated Punch for the .420 Fittings	34

Garden Hose Fittings

Brass Hose Adapters



MHT × MHT

ITEM #		PRICE
BGH1625	MHT × MHT	3.68
BGH1624	MHT × 3/4" MHT	4.36



FHT × 3/4" FPT

ITEM #		PRICE
BGH1635	FHT × 3/4" FPT	5.12



Garden Hose Camlock

ITEM #		PRICE
GARCAF	Garden Hose Camlock Fht × Male Camlock	6.1
GARCAM	Garden Hose Camlock Mht × Female Camlock	11.4

Plastic FHT × 1/2" Slip-3/4" SPIG



ITEM #		PRICE
GHF67	FHT × 1/2" SOC-3/4" SPIG	1.67

Male Brass Hose Ends

These fittings replace your hose ends and use a clamp or we are now able to crimp hose ends onto your garden hose. Bring your garden hose in and have a professional looking crimp without the bulky hose clamps. You can also order a custom length garden hose without having a whole lot of extra or not enough of hose. We can do 5/8" and 3/4" garden hose.



ITEM #		PRICE
BGH006	5/8"	3.8
BGH007	3/4"	4.46

Female Brass Hose Ends

These fittings replace your hose ends and use a clamp or we are now able to crimp hose ends onto your garden hose. Bring your garden hose in and have a professional looking crimp without the bulky hose clamps. You can also order a custom length garden hose without having a whole lot of extra or not enough of hose. We can do 5/8" and 3/4" garden hose.



ITEM #		PRICE
BGH066	5/8"	3.95
BGH077	3/4"	3.95



FHT × FHT

ITEM #		PRICE
BGH1628	FHT × FHT (Swivel)	3.62

4 Outlet Brass Hose Manifold, w/1/4 valve



ITEM #		PRICE
BBV04	4 Outlet Manifold	19.22

MHT × Slip SPIG



ITEM #		PRICE
GHF37	MHT × 3/4" SOC/1" SPIG	1.25

Brass Twin Shut-off Valve



ITEM #		PRICE
BBV0077	Brass Wye	7.38

GHT Tee w/ Filter



ITEM #	PRICE
DTFGHT GHT Tee w/Filter	7.29

Filter for GHT Tee



ITEM #	PRICE
DTFGHTF Fits DTFGHT Filter	5.43

Tank Bulkheads



ITEM #	PRICE
BULHE.75 0.75" Bulkhead • 5/8" Hole	9.22
BULHE1 1" Bulkhead • 2.25" Hole	8.37
BULHE1.5 1.5" Bulkhead • 3" Hole	13.6
BULHE2 2" Bulkhead • 3.25" Hole	20.3

Male Plastic Hose Ends



ITEM #	PRICE
GHF17 5/8" - 3/4"	1.37

Female Plastic Hose Ends



ITEM #	PRICE
GHF07 5/8" - 3/4"	1.37

Hose End Cap (FHT)



ITEM #	PRICE
GHF7	0.63

Rubber Hose Washers



ITEM #	PRICE
GHF12 Pack of 10	1.29
GHF14 Hose Washers w/Screen	0.54

Plastic FHT × 3/4" Slip/1" SPIG



ITEM #	PRICE
GHF47 FHT × 3/4" SOC/1" SPIG	1.8

Dramm Garden Hose

Need a quality kink resistant hose? Dramm rubber hose is made for many applications and comes with factory crimped ends. (no clamps to mess with).



ITEM #	PRICE
RBRH5034 3/4" × 50'	111.75
RBRH10034 3/4" × 100'	180
RBRHS50 5/8" × 50'	67.97
RBRHS100 5/8" × 100'	128.84

Stainless Steel Tee Insert × MPT



ITEM #	PRICE
BF1401007 3/4"	11.8
BF1401010 1" Tee Insert × MPT	15.95
BF1403131 1" × 3/4"	13.37
BF1403133 1.25" × 1" Brass	29.66

Stainless Steel Insert Coupling



ITEM #	PRICE
BF1404025 1.25"	7.34
BF1404075 0.75"	3.89
BF1404010 1"	7.34

Stainless Steel Insert Tees



ITEM #		PRICE
BF1402010	1" Tee Insert x Insert	12.73
BF1402075	3/4" Tee Insert x Insert	9.83
BF14021075	1" x 3/4" Tee Insert x Insert	12.64
BF1402125	1.25" Tee Insert x Insert	20.69

Plastic FHT x 3/4" MPT Swivel



ITEM #		PRICE
GHF87	FHT x 3/4" MPT (Swivel)	1.35

Plastic Hose Mender



ITEM #		PRICE
GHF27	5/8" - 3/4"	1.51

Plastic MHT x 1/2" Slip-3/4" SPIG



ITEM #		PRICE
GHF57	MHT x 1/2" SOC-3/4" SPIG	0.99

Bulk Garden Hose

Try our higher quality hexagon shaped garden hose for better kink resistant and durability. Instead of bulky hose clamps, we can crimp the hose ends. Order a custom length 5/8" or 3/4" garden hose.



ITEM #		PRICE	
GHG006	Garden Hose 5/8"	1.37	Qty 700+
	Bulk Roll of 325'		\$1.23
GHG075	Garden Hose 3/4"	1.58	Qty 330+
	Bulk Roll of 330'		\$1.42
GHGD006	Garden Hose 5/8"	1.24	Qty 330+
	(yellow)		\$1.14
	Bulk Roll of 330'		

Brass Live FHT x MHT Hose Swivel

Our heavy-duty Brass Hose Swivel is a live swivel, meaning it swivels under pressure, allowing unencumbered movement between the hose and attachment. Now hose can be unwound without having to manually twist the hose. Wands can be oriented in any direction without fighting the hose.



ITEM #		PRICE
BGH1627	Brass FHT x MHT Hose Swivel	13.94

Stainless Steel Hydrant Elbow, Insert x MPT



ITEM #		PRICE
BF1406007	3/4"	8.19
BF1413010	1"	11.66
BF1403751	1" x 3/4" SS	9

Brass Check Valves

Full Flow FIPT x FIPT



ITEM #		PRICE
BCV007	3/4"	9.36
BCV010	1"	13.8
BCV015	1.5"	29.99
BCV020	2"	47.55
BCV030	3"	108.8
BCV040	4"	165.61

Stainless Steel Ball Valves - Full Flow FIPT x FIPT



ITEM #		PRICE	ITEM #		PRICE
BBV005	1/2"	12.41	BBV015	1.5"	29.76
BBV007	3/4"	17.73	BBV020	2"	59.94
BBV010	1"	25.88	BBV030	3"	136.5
BBV012	1.25"	35.46	BBV040	4"	233.52

Brass Gate Valves

Heavy Duty FPT x FPT



ITEM #		PRICE
BGV005	1/2"	8.69
BGV007	3/4"	11
BGV010	1"	15.8
BGV015	1.5"	25.72

ITEM #		PRICE
BGV020	2"	37.82
BGV030	3"	91.31
BGV040	4"	146.86

Stainless Steel Insert Elbow



ITEM #		PRICE
BF1401075	3/4" x 3/4" SS Insert Elbow	7.52
BF1401100	1" x 1" SS Insert Elbow	10.91
BF1401125	1.25" x 1.25" SS Insert Elbow	16.96

PVC Compression Coupling

Use for repair of PVC pipe in an existing underground line, without digging up large sections of the pipe.



ITEM #		PRICE
SPF7015	1.5"	3.92
SPF7020	2"	4.91
SPF7030	3"	13.95
SPF7040	4"	18.73

Slip PVC Ball Valves



ITEM #	PRICE	ITEM #	PRICE
PBVS005	1/2" 1.86	PBVS015	1 1/2' 5.3
PBVS007	3/4" 2.27	PBVS020	2" 8.45
PBVS010	1" 3.11	PBVS030	3" 31.5
PBVS012	1.2" 4.32	PBVS040	4" 53

Threaded PVC Ball Valves



ITEM #	PRICE	ITEM #	PRICE
PBVT005	1/2" 1.86	PBVT015	1 1/2" 5.3
PBVT007	3/4" 2.27	PBVT020	2" 8.45
PBVT010	1" 3.11	PBVT030	3" 31.5
PBVT012	1.2" 4.32	PBVT040	4" 53

MPT x Insert Adapter

Use both PTFE Tape & Pipe Thread Compound together for joining stainless steel threaded connections.



ITEM #		PRICE
BF1436007	3/4"	6.73
BF1436010	1" SS	9.95
BF1436025	1.25" SS	12.85
BF14360701	3/4" x 1" SS	7.86
BF14362501	1.25" x 1" SS	11.27

Brass Ball Valves (Insert)

Full Port Insert x Insert



ITEM #		PRICE
BBVI007	3/4"	21.8
BBVI010	1"	24.99
BBVI012	1.2"	27.9

Brass Boiler Drain Valve



ITEM #		PRICE
BBD005	1/2"	10.34
BBD007	3/4"	11.29

Brass Pressure Relief Valve

Preset at 75 PSI



ITEM #		PRICE
BPR07	3/4"	9.25

Pressure Gauges

Metal case with plastic face with 1/4" MPT brass stem. All systems need pressure gauges! Not using pressure gauges in the system can be very costly. It's like working in the dark!



1/4" MPT
2" Face

ITEM #		PRICE
PG30	30 PSI	3.95
PG60	60 PSI	3.95
PG100	100 PSI	3.95
PG200	200 PSI	3.95
PGL100	Liquid Filled • 100 PSI	6.93
PGL200	Liquid Filled • 200 PSI	6.93
PGB10025	Backmount • 100 PSI - 1/4" MPT	4.5

Steel Fittings

All fittings are insert

ITEM #		PRICE
SFC2	2" Coupling	5.45
SFC3	3" Coupling	12.65
SFM010	1" MPT x INS	2.66
SFM2	2" MPT x INS	5.47
SFM3	3" MPT x INS	12.92
SFM4	4" MPT x INS	\$18.58

Suction Strainers

Fipt Steel

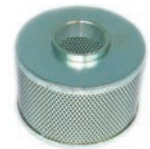

ITEM #		PRICE
SS021	2" Fine	19.39
SS020	2"	15.34
SS030	3"	106.16
SS040	4"	106.16



Ball Valve Union FPT

ITEM #		PRICE
U8FB010	1"	14.77
U8FB015	1 1/2"	24
U8FB020	2"	33.11

Stake Assembly for Pressure Gauge



ITEM #	PRICE
PGS	9.94



SPEARS SCH40 Quality Pipe Fittings • Made in USA

SPIG= Fitting is the same size as the pipe • SLIP= Fitting glues on outside of pipe

90° Elbow

Slip x Slip

ITEM #		PRICE
SPF406005	1/2"	0.66
SPF406007	3/4"	0.72
SPF406010	1"	0.99
SPF406015	1 1/2"	1.75
SPF406020	2"	2.72
SPF406030	3"	8.31
SPF406040	4"	13.52



Tee

Slip x Slip x Slip

ITEM #		PRICE
SPF401005	1/2"	0.76
SPF401007	3/4"	0.87
SPF401010	1"	1.23
SPF401015	1 1/2"	2.32
SPF401020	2"	2.91
SPF401030	3"	11.43
SPF401040	4"	19.49

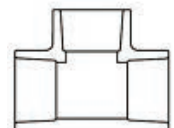

90° Elbow

Slip x Male Pipe Thread

ITEM #		PRICE
SPF410005	1/2"	0.99
SPF410007	3/4"	1.17
SPF410010	1"	1.96
SPF410015	1 1/2"	2.86
SPF410020	2"	5.87

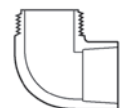



Reducing Elbow

Slip × Slip

ITEM #		PRICE
SPF406101	3/4" × 1/2"	1.32
SPF406251	2" × 1 1/2"	5.86

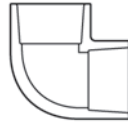

Tee

Female Pipe Thread × Female Pipe Thread × Female Pipe Thread

ITEM #		PRICE
SPF405005	1/2" Coupling	2.08
SPF405007	3/4" Coupling	3.14
SPF405010	1" Coupling	3.9
SFM010	1" MPT × INS	2.66
SPF405015	1-1/2"	5.4
SPF405020	2"	6.91

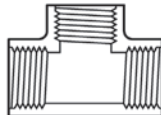

Tee

Slip × Slip × Female Pipe Thread

ITEM #		PRICE
SPF402005	1/2"	1.13
SPF402007	3/4"	1.17
SPF402010	1"	2.16
SPF402015	1 1/2"	4
SPF402020	2"	4.89
SPF402030	3"	16.46
SPF402040	4"	

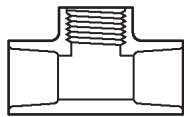

Reducing Tee

Slip × Female Pipe Thread

ITEM #		PRICE
SPF402101	3/4" × 1/2"	0.99
SPF402130	1" × 1/2"	1.51
SPF402131	1" × 3/4"	2.16
SPF402211	1.5" × 1"	3.86
SPF402248	2" × 3/4"	4.69
SPF402249	2" × 1"	4.69
SPF402251	2" × 1 1/2"	4.69
SPF402422	4" × 3"	20.29

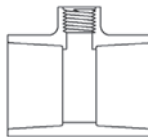

45° Elbow

Slip × Slip

ITEM #		PRICE
SPF417005	1/2"	0.99
SPF417007	3/4"	1.17
SPF417010	1"	1.39
SPF417020	2"	3.21
SPF417030	3"	10.8
SPF417040	4"	17.35

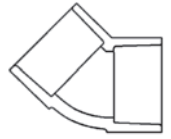

Adapter

Female Pipe Thread × SPIG

ITEM #		PRICE
SPF478005	1/2"	0.8
SPF478007	3/4"	0.9
SPF478010	1"	1.16
SPF478015	1 1/2"	1.85
SPF478020	2"	2.62
SPF478030	3"	7.25

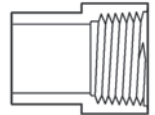

Coupling

Slip × Slip

ITEM #		PRICE
SPF429005	1/2"	0.43
SPF429007	3/4"	0.57
SPF429010	1"	0.98
SPF429015	1 1/2"	1.11
SPF429020	2"	1.7
SPF429030	3"	4.71
SPF429040	4"	6.39

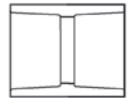

Coupling

Female Pipe Thread × Female Pipe Thread

ITEM #		PRICE
SPF430005	1/2"	0.78
SPF430007	3/4"	1.07
SPF430010	1"	1.39

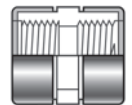



Bushing

SPIG × Female Pipe Thread

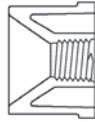

ITEM #		PRICE
SPF438072	1/2" × 1/4"	1.07
SPF438098	3/4" × 1/4"	1.07
SPF438101	3/4" × 1/2"	1.06
SPF438130	1" × 1/2"	1.34
SPF438131	1" × 3/4"	1.34
SPF438168	1 1/4" × 1"	1.87
SPF438210	1 1/2" × 3/4"	2.16
SPF438211	1 1/2" × 1"	2.16
SPF438248	2" × 3/4"	2.9
SPF438249	2" × 1"	2.9
SPF438251	2" × 1 1/2"	2.9
SPF438291	2 1/2" × 1 1/2"	3.75
SPF438338	3" × 2"	4.32
SPF438420	4" × 2"	8.58
SPF438422	4" × 3"	8.58

Adapter

Female Pipe Thread × Slip

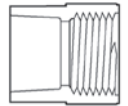

ITEM #		PRICE
SPF435005	1/2"	0.72
SPF435007	3/4"	0.92
SPF435010	1"	1.06
SPF435015	1 1/2"	1.33
SPF435020	2"	1.79
SPF435030	3"	5.27
SPF435040	4"	7.91

Adapter

Male Pipe Thread × Slip

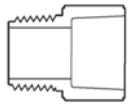

ITEM #		PRICE
SPF436005	1/2"	0.57
SPF436007	3/4"	0.66
SPF436010	1"	1.15
SPF436015	1 1/2"	1.45
SPF436020	2"	1.75
SPF436030	3"	6.31
SPF436040	4"	7.56

Reducing Adapter

Male Pipe Thread × Slip

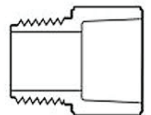

ITEM #		PRICE
SPF436074	1/2" × 3/4"	1.15
SPF436101	3/4" × 1/2"	1.06
SPF436102	3/4" × 1"	1.27
SPF436131	1" × 3/4"	2.52
SPF436213	1 1/2" × 2"	3.33
SPF436251	2" × 1 1/2"	3.78
SPF436342	3" × 4"	10

Cap

Slip



ITEM #		PRICE
SPF447005	1/2"	0.57
SPF447007	3/4"	0.69
SPF447010	1"	1.06
SPF447015	1 1/2"	1.17
SPF447020	2"	1.39
SPF447030	3"	4.07
SPF447040	4"	8.7

Cap

Female Pipe Thread



ITEM #		PRICE
SPF448005	1/2"	0.98
SPF448007	3/4"	1.12
SPF448010	1"	1.64
SPF448015	1 1/2"	1.87
SPF448020	2"	3.2
SPF448030	3"	5.33
SPF448040	4"	8.78



Bushing

SPIG × Slip

ITEM #		PRICE
SPF437101	3/4" × 1/2"	0.69
SPF437130	1" × 1/2"	0.98
SPF437131	1" × 3/4"	0.98
SPF437210	1 1/2" × 3/4"	1.34
SPF437211	1 1/2" × 1"	1.34
SPF437248	2" × 3/4"	2
SPF437249	2" × 1"	2
SPF437251	2" × 1 1/2"	2
SPF437337	3" × 1 1/2"	4.18
SPF437338	3" × 2"	4.18
SPF437422	4" × 3"	8.46



Bushing

Male Pipe Thread × Female Pipe Thread

ITEM #		PRICE
SPF439072	1/2" × 1/4"	2.16
SPF439098	3/4" × 1/4"	1.45
SPF439101	3/4" × 1/2"	1.45
SPF439130	1" × 1/2"	1.87
SPF439131	1" × 3/4"	1.87
SPF439166	1 1/4" × 1/2"	\$3.47
SPF439168	1 1/4" × 1"	2.78
SPF439210	1 1/2" × 3/4"	3.24
SPF439211	1 1/2" × 1"	3.24
SPF439212	1 1/2" × 1 1/4"	3.24
SPF439249	2" × 1"	3.47
SPF439250	2" × 1 1/4"	3.47
SPF439251	2" × 1 1/2"	3.47
SPF439292	2 1/2" × 2"	9.88
SPF439338	3" × 2"	11.68

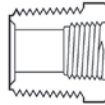

Plug

SPIG

ITEM #		PRICE
SPF449005	1/2"	1.07
SPF449020	2"	2.96
SPF449030	3"	5.57

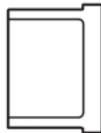

Adapter

Insert × SPIG

ITEM #		PRICE
SPF460005	1/2"	1.61
SPF460007	3/4"	1.98
SPF460010	1"	2.11
SPF460015	1 1/2"	2.35
SPF460020	2"	3.62
SPF460030	3"	10.73
SPF460040	4"	12.36

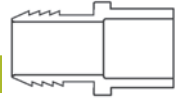

Plug

Male Pipe Thread

ITEM #		PRICE
SPF450005	1/2"	1.23
SPF450007	3/4"	1.31
SPF450010	1"	2.16
SPF450015	1 1/2"	2.44
SPF450020	2"	3.14
SPF450030	3"	5.52
SPF450040	4"	11.88



Adapter

SPIG × Male Pipe Thread

ITEM #		PRICE
SPF461007	3/4"	1.15
SPF461010	1"	1.43
SPF461015	1 1/2"	2.34
SPF461020	2"	2.88

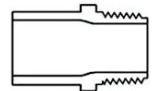

Tee

Insert × Insert × Male Pipe Thread

ITEM #		PRICE
PIF1403007	3/4"	3.19
PIF1403010	1"	3.64
PIF1403015	1 1/2"	5.3
PIF1403020	2"	7.71

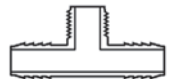



90° Elbow

Insert × Insert

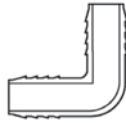

ITEM #		PRICE
PIF1406005	1/2"	1.53
PIF1406007	3/4"	1.87
PIF1406010	1"	2.08
PIF1406015	1 1/2"	2.74
PIF1406020	2"	3.83
PIF1406030	3"	21.86
PIF1406040	4"	42.22

Reducing Tee

Insert × Female Pipe Thread × Insert

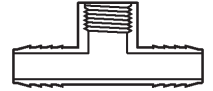

ITEM #		PRICE
PIF1402101	3/4" × 1/2"	2.28
PIF1402131	1" × 3/4"	2.98
PIF1402210	1 1/2" × 3/4"	6.63
PIF1402211	1 1/2" × 1"	6.63
PIF1402248	2" × 3/4"	7.42
PIF1402249	2" × 1"	8.14
PIF1402251	2" × 1 1/2"	8.55

90° Elbow

Insert × Female Pipe Thread

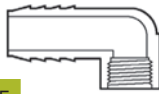

ITEM #		PRICE
PIF1407005	1/2"	1.73
PIF1407007	3/4"	1.87
PIF1407010	1"	2.42
PIF1407015	1 1/2"	3.64
PIF1407020	2"	6.14

Reducing 90° Elbow

Insert × Female Pipe Thread

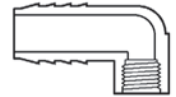

ITEM #		PRICE
PIF1407101	3/4" × 1/2"	1.77
PIF1407131	3" × 3/4"	2.18
PIF1407211	1 1/2" × 1"	3.69
PIF1407251	2" × 1 1/2"	5.84

Reducing Tee

Insert × Insert × Insert



ITEM #		PRICE
PIF1401101	3/4" × 1/2"	2.1
PIF1401131	1" × 3/4"	2.49
PIF1401210	1 1/2" × 3/4"	4.95
PIF1401211	1 1/2" × 1"	4.95
PIF1401247	2" × 1/2"	6.5
PIF1401248	2" × 3/4"	6.6
PIF1401249	2" × 1"	6.6
PIF1401251	2" × 1 1/2"	7.2

90° Elbow

Insert × Male Pipe Thread

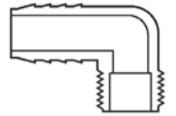

ITEM #		PRICE
PIF1413005	1/2"	1.94
PIF1413007	3/4"	2.68
PIF1413010	1"	3.51
PIF1413015	1 1/2"	5.53
PIF1413020	2"	8.16

Tee

Insert × Insert × Insert

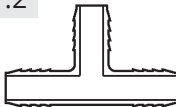

ITEM #		PRICE
PIF1401005	1/2"	1.69
PIF1401007	3/4"	1.87
PIF1401010	1"	2.41
PIF1401015	1 1/2"	3.56
PIF1401020	2"	6.92
PIF1401030	3"	28.45
PIF1401040	4"	56.87

Cross

Insert × Insert × Insert × Insert



ITEM #		PRICE
PIF1420007	3/4"	3.95
PIF1420010	1"	4.88

Teflon Tape

ITEM #		PRICE
TAP005	1/2" × 520'	0.95
TAP010	1" × 520'	1.25



Reducing Coupling

Insert × Insert



ITEM #		PRICE
PIF1429101	3/4" × 1/2"	1.27
PIF1429131	1" × 3/4"	1.33
PIF1429211	1 1/2" × 1"	3.14
PIF1429251	2" × 1 1/2"	3.51
PIF1429338	3" × 2"	22.44
PIF1429422	4" × 3"	37.36

Adapter

Insert × Female Pipe Thread

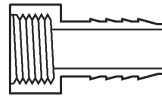

ITEM #		PRICE
PIF1435005	1/2"	3.43
PIF1435007	3/4"	3.59
PIF1435010	1"	3.69
PIF1435015	1 1/2"	5.75
PIF1435020	2"	6.83

Adapter

Insert × Male Pipe Thread

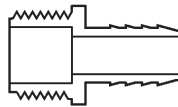

ITEM #		PRICE
PIF1436005	1/2"	1.09
PIF1436007	3/4"	1.28
PIF1436010	1"	1.3
PIF1436012	1 1/4"	1.53
PIF1436015	1 1/2"	1.73
PIF1436020	2"	3.31
PIF1436030	3"	12.25
PIF1436040	4"	16.77

Reducing Adapter

Male Pipe Thread × Insert

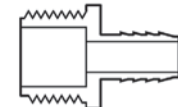

ITEM #		PRICE
PIF1436074	1/2" × 3/4"	2.44
PIF1436101	3/4" × 1/2"	2.2
PIF1436102	3/4" × 1"	2.54
PIF1436131	1" × 3/4"	2.28
PIF1436133	1" × 1 1/2"	4
PIF1436211	1 1/2" × 1"	3.51
PIF1436213	1 1/2" × 2"	4.96
PIF1436251	2" × 1 1/2"	5.28

TEE

Insert × Female Pipe Thread

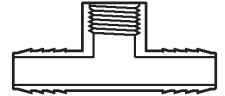

ITEM #		PRICE
PIF1402005	1/2"	1.87
PIF1402007	3/4"	2.74
PIF1402010	1"	3.25
PIF1402015	1 1/2"	6.88
PIF1402020	2"	8.55

Coupling

Insert × Insert

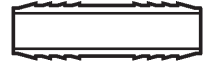

ITEM #		PRICE
PIF1429005	1/2"	0.85
PIF1429007	3/4"	0.93
PIF1429010	1"	0.99
PIF1429015	1 1/2"	1.73
PIF1429020	2"	3.27
PIF1429030	3"	11.6
PIF1429040	4"	14.84

Plug

Insert

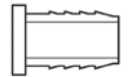

ITEM #		PRICE
PIF1449005	1/2"	1.39
PIF1449007	3/4"	1.45
PIF1449010	1"	1.88
PIF1449015	1 1/2"	2.7
PIF1449020	2"	4.14
PIF1449030	3"	18.06

Adapter

Insert × Slip

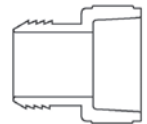

ITEM #		PRICE
SPF474005	1/2"	1.45
SPF474007	3/4"	1.75
SPF474010	1"	1.85
SPF474015	1 1/2"	3.14
SPF474020	2"	5.22
SPF474030	3"	13.52



SPEARS SCH40 Quality Pipe Fittings • Made in USA

SCH40 Slip Fittings for Poly Tubing - Compression Rings

ITEM #		PRICE
OTCA05	1/2"	0.49
OTCA07	3/4"	0.99

PVC Pipe Cement

ITEM #		PRICE
PVC	1/2 Pint	6.68
PVC1	1 Pint	11.31
PVC2	1/2 Pint Primer	7



SCH80 Nipples MIPT x MIPT

ITEM #		PRICE
S8N015C	1/2" x Close	0.47
S8N0152	1/2" x 2 1/2"	0.67
S8N75	3/4" x Close	0.59
S8N756	3/4" x 6"	1.26
S8N1C	1" x Close	0.92
S8N16	1" x 6"	1.86
S8N125	1 1/4" x Close	1.47
S8N15C	1 1/2" x Close	1.55
S8N156	1 1/2" x 6"	2.94
S8N2C	2" x Close	1.45
S8N26	2" x 6"	2.48
S8N25	2 1/2" x Close	3.76
S8N3C	3" x Close	3.98
S8N38	3" x 8"	8.35
S8N4C	4" x Close	6.37
S8N48	4" x 8"	10.93

PVC Unions Slip Durable Viton Seal

ITEM #		PRICE
U8S007	3/4"	3.49
U8S010	1"	3.97
U8S015	1 1/2"	8.46
U8S020	2"	12.31



PVC Unions Fipt Durable Viton Seals

ITEM #		PRICE
U8F007	3/4"	3.61
U8F010	1"	4.84
U8F015	1 1/2"	8.82
U8F020	2"	13.24



Pipe Joint Compound

ITEM #		PRICE
PJC05	1/2" Pint	8.95



Tubing End Closure

ITEM #		PRICE
DTFF8.1	1" Figure 8	
DTFF8.5	1/2" Figure 8	0.23
DTFF8.75	3/4" Figure 8	0.49



Fittings

Power-Loc Fittings for Orchard Tube

Power-Loc Elbow



ITEM #		PRICE
PL50ELL	1/2"	1.62
PL80ELL	3/4"	3.79
PL100ELL	1"	4.38

Power-Loc x .400 Barb



ITEM #		PRICE
PL5040B	1/2"	1.08
PL8040B	3/4"	\$1.71

Power-Loc × Coupling



ITEM #		PRICE
PL50C	1/2"	1.11
PL80C	3/4"	2.18
PL100C	1"	2.57

Power-Loc End



ITEM #		PRICE
PL50END	1/2"	1.47
PL80END	3/4"	2.21

Power-Loc × MPT



ITEM #		PRICE
PL80MPT75	3/4" Power-Loc × 3/4" MPT	1.47
PL50MPT5	1/2" Power-Loc × 1/2" MPT	0.94
PL100MPT10	1" Power-Loc × 1" MPT	1.92

Power-Loc × MHT



ITEM #		PRICE
PL50HT	1/2" Power-Loc x MHT	0.98
PL80HT	3/4" Power-Loc x MHT	1.53
PL100HT	1" Power-Loc x MHT	1.88

Power-Loc to Lay-flat



ITEM #		PRICE
PL50LF	1/2" Power-Loc to Lay-Flat	1.87
PL80LF	3/4" Power-Loc to Lay-Flat	3.95

Power-Loc to FHT



ITEM #		PRICE
PL50PHS	1/2" Power-Loc to FHT	1.4
PL80PHS	3/4" Power-Loc to FHT	2.76
PL100PHS	1" Power-Loc to FHT	4.24

Power-Loc to Flush End



ITEM #		PRICE
PL50AF	1/2" Power-Loc Auto Flush End	2.34
PL80AF	3/4" Power-Loc Auto Flush End	2.6

Power-Loc Tee



ITEM #		PRICE
PL50P3T	1/2"	1.97
PL80P3T	3/4"	4.7
PL100P3T	1"	5.93

Power-Loc Ball Valve



ITEM #		PRICE
PL50BV	1/2"	2.09
PL80BV	3/4"	4.21
PL100BV	1"	6.47

PL50SOC/SPIG



ITEM #		PRICE
PL50SOC/SPRIG	1/2" Power Loc x 3/4" Spig/1/2 SOC	\$0.98
PL80SOC/SPRIG	3/4" Power Loc x 3/4" Spig/1/2" SOC	\$1.49

Hosing and Pipe

PVC SCH40 Pipe

Sold in 20' sections



ITEM #	SIZE	PRICE	100+
S40005	1/2"	0.62	\$0.74
S40007	3/4"	0.7	\$0.85
S40010	1"	1	\$1.20
S40015	1 1/2"	1.49	\$1.87
S40020	2"	1.95	\$2.34
S40030	3"	3.65	\$4.17
S40040	4"	4.4	\$5.65

Black Poly Pipe 200PSI

The poly pipe is used for wells, underground lines and for high pressure applications. Stocked in 100' & 300' Rolls.



ITEM #	SIZE	PRICE
BPP07100	3/4" x 100'	49.89
BPP07300	3/4" x 300'	145.73
BPP01100	1" x 100'	69.29
BPP01300	1" x 300'	199.77
BPP12100	1.25" x 100'	109.39
BPP12300	1.25" x 300'	315.53

Low Pressure Poly Oval Hose

Oval Hose is a lightweight low cost tubing designed to be used for headlines and low pressure applications.



ITEM #	SIZE	PSI	WEIGHT	PRICE
FPT153	1.5" x 300'	21	#35	\$77.88
FPT156	1.5" x 600'	21	#62	\$119.39
FPT2025	2" x 225'	21	#79	73.71
FPT2045	2" x 450'	21	#70	143.37
FPT302	3" x 200'	21	#65	160

Clear Braided Hose

Clear Braided Hose is a thick & stiff chemical resistant hose that can be used in high pressure applications and also as a light suction hose. 10% discount for a 100' roll



ITEM #	SIZE	PSI	PRICE
CBH002	1/4"	250	1
CBH003	3/8"	225	1.14
CBH005	1/2"	200	1.33
CBH007	3/4"	150	1.86
CBH010	1"	125	2.81

Clear Vinyl Tubing

Clear Vinyl Tubing is commonly used for fertilizer injectors as it is resistant to most chemicals. Rated at 55PSI.



ITEM #	SIZE	PRICE
CVT002	1/4" Clear Vinyl Tubing	0.35
CVT375	5/16" Clear Vinyl Tubing	0.73
CVT437	7/16" Clear Vinyl Tubing	0.73

SDR Underground Pipe

ITEM #	SIZE	PRICE
S26020	2"	2.28
S26030	3"	3.87
S26040	4"	5.76



Ironside Red Lay-flat Discharge Hose

Ironside's features high working pressure and resists kinking and twisting. Also sold by foot.

ITEM #	SIZE	PSI	PRICE
IRL015	1 1/2" x 300'	150	305.79
IRL020	2" x 300'	150	399.56
IRL030	3" x 300'	150	635.11
IRL040	4" x 300'	150	973.55

Lay-flat Discharge Hose

Lightweight, tough and economical water discharge hose great for running water to the field. It's used for mainlines in drip irrigation or transferring water. Hose rolls up in a nice flat coil. It is very popular because it will not rot or mildew and coils flat for storage.

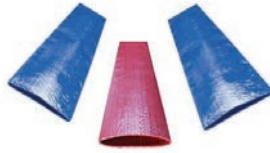

ITEM #	SIZE	PSI	WEIGHT	PRICE
LAY015	1 1/2" x 300'	80	#48	122.02
LAY020	2" x 300'	80	#69	135.26
LAY030	3" x 300'	70	#117	289.17
LAY040	4" x 300'	70	#156	416.55

Suction Hose

This suction hose may not be the cheapest but it is a high quality hose that will not collapse. Comes on a 100' roll but we will cut to length.



ITEM #	PRICE	100+	
TIG015	1 1/2"	3.41	\$3.09
TIG020	2"	3.98	\$3.58
TIG030	3"	6.97	
TIG040	4"	12.37	

Orchard Tubing

Orchard tubing is similar to the Oval Hose but is mainly used in greenhouse applications. However, it can hold more pressure than the Oval Hose. This is a lateral distribution & supply hose for on-line drippers, weighted drip tubes, micro-sprinklers and can be used as a headline for small drip tape systems.



ITEM #	SIZE	PSI	WEIGHT	PRICE
BPT0051	1/2" x 100'	55	#5	16.77
BPT0055	1/2" x 500'	55	#22	41.14
BPT0059	1/2" x 1000'	55	#44	76.2
BPT0071	3/4" x 100'	55	#8	13.28
BPT0075	3/4" x 500'	55	#36	58.73
BPT00710	3/4" x 1000'	55		110.84
BPT0100	1" x 100'	46	#9	22.34
BPT0102	1" x 250'	46	#21	46.61
BPT01660	1" x 660'	46	#58	123.04

irritec *TAPE* PREMIUM LIGHT DRIPLINE



- Premium Light Dripline with Seamless Construction
- Manufactured with Engineering Grade Polyethylene Resins for High Strength
- Two Stripes for Correct Installation
- Highly Uniform Water Distribution with a Cv of <2.0%
- Continuous Labyrinth with Integrated Inlet Filter for Additional Clogging Protection
- Laser Drilled Outlet Reduces Root Intrusion and Siphon Plugging

ITEM #	DESCRIPTION	SIZE	GPM	LENGTH	PRICE	20+
IRR04119	Q9 Drip Tape 8 mil, 4", 1.19 gpm, 7,540'	4"	1.19	7,540'	162.5	\$158.03
IRR0654	Q9 Drip Tape 8 mil, 6", .54 gpm, 7,540'	6"	.54	7,540'	162.5	\$158.03
IRR0840	Q9 Drip Tape 8 mil, 8", .40 gpm, 7,540'	8"	.40	7,540'	162.5	\$158.03
IRR101253	Q9 Drip Tape 10 mil, 12", .53 gpm, 6,000'	12"	.53	6,000'	175.8	\$152.70
IRR102430	P1 Drip Tape 10 mil, 24", .33 gpm, 7,546'	24"	.33	6,000'	175.8	\$152.70
IRR1224	Q9 Drip Tape 8 mil, 12", .24 gpm, 7,540'	12"	.27	7,540'	162.5	\$158.03
IRR1247	Q9 Drip Tape 8 mil, 12", .48 gpm, 7,540'	12"	.53	7,540'	162.5	\$158.03
IRR60853	Q9 Drip Tape 6 mil, 8", .59 gpm, 10,000'	8"	.59	10,000'	175.8	\$172.28

Characteristics and Advantages

- Two stripes identify the dripline side with the exit holes ensuring correct installation.
- Target markets include row crop (surface, subsurface and under mulch), open field and greenhouse.
- Excellent choice for close dripper spacing, low application rates and extended performance in the field.
- The integrated inlet filter and extra large cross section provide plugging protection.
- Laser drilled dripper outlet prevents root intrusion and siphon plugging.
- Exceptional filtration performance extends the range of usable fertilizers.
- A lower Cv, <2% results in highly uniform water distribution.
- Less susceptible to damage during installation and easily retrievable.
- UV resistant and resistant to common fertilizers.
- Recommended filtration: 200 Mesh for .07 GPH and .09 GPH
150 Mesh for .14 GPH, .21 GPH and .28 GPH





Apex PC Heavy Wall Dripline

- Pressure compensating dripper is non-CNL and has the largest filtration area in its class
- resulting in superior clog resistance.
- Wide pressure compensation range of 7 to 60 psi.
- Excellent water distribution uniformity - from the top to the bottom of the row, every plant gets the same amount of water.
- High quality resins assure durable performance and long life.
- Dripper has a chemical resistant silicon diaphragm and MDPE body.
- Ideal for permanent crops such as nut trees, fruit trees and vineyards.
- Seven year non-prorated warranty against defects in materials or workmanship.
- Coils are rolled tight and consistent for easy installation.
- A Cv less than 5% allows design flexibility for surface or subsurface applications.
- Resistant to UV, common fertilizers and environmental stress cracking.
- Recommended filtration: 120 Mesh for all flow rates
- 18 MM, .55 GPH per dripper



ITEM #	DESCRIPTION	PRICE
DRP1812	1/2 x 1,000' 12" Spacing Apex PC	119.15
DRP1818	1/2 x 1,000' 18" Spacing Apex PC	97.22
DRP1824	1/2 x 1,000' 24" Spacing Apex PC	86.22
DRP1830	1/2 x 1,000' 30" Spacing Apex PC	79.68
DRP1836	1/2 x 1,000' 36" Spacing Apex PC	75.29

BTF Low & Medium Flow 6" Drip Spacing

Unlike other tapes, Chapin Tape has a unique extruded film profile with extra strength and thickness where it is needed most: the rounded tape edges that increase resistance to abrasion and insect damage.

All Chapin turbulent flow paths have larger internal dimension, providing extraordinary resistance to clogging. Chapin drip tape consistently supplies the narrowest manufacturer's variations (CVs) in the industry for unmatched uniformity.

In addition, carefully controlled lower tension winding on reels results in easier installation thanks to less retraction, kinking and snaking in the field.

With decades of proven performances, a wide variety of flow rates, wall thicknesses and outlet spacings, Chapin drip tape provides consistently outstanding performance for the most demanding applications.

Note: Remember not to lay drip tape under tension, as stretching could occur, resulting in a damaged emitter.

Developed to our specifications. Longer runs and better uniformity than any other drip tape at 4" or 6" spacing!



Drip Tape

ITEM #	MIL	SPACING	GPM/100	LENGTH	LB	PRICE	16+
CH1000	8	6"	.50	1,000' /roll	10	\$51.27	
11703310	8	6"	.50	7,500' /roll	68	\$164.62	\$161.33
11703320	8	8"	.40	7,500' /roll	68	\$164.62	\$161.33
11703400	8	12"	.25	7,500' /roll	68	165	\$161.33
11703430	8	12"	.50	7,500' /roll	65	\$164.62	\$161.33

Mulch Bed Layers



Rain Flo 2470 Raised Bed Plastic Layer

- Will lay 4' plastic, 30" bed top, with minimum 58" row spacing
- Adjustable 3" to 5" bed height
- Requires minimum 30-hp with 4-wheel drive
- 50 gal. water tank to adjust weight to match tractor size
- Compact machine for high tunnels and small tractors
- Adjustable tension brake on plastic roll carriers
- Replaceable, reversible plow shares
- 3/8" & 1/2" UHMW poly lined bed press
- Category 1 or 2 - 3-point hitch

Options

- Optional single or double drip applicator
- Optional center fillers, for heavy soil
- Optional crowned bed available

ITEM #	PRICE
RAI2470	3875

Rain-Flo 2570 & 2670 Raised Bed Mulch Layers (Series II)

2570 Mulch Layer W/ Auto Ro-Track



- 60" row centers with 4' plastic, 60 hp FWD minimum
- Adjustable plastic width from 3 ft. or 4 ft. wide plastic
- Adjustable bed height from 3" to 7" high bed
- On the go cover disk adjustment
- Adjustable brake tension on plastic roll carriers
- Bed press has adjustable side press plates
- With operator seat
- Adjustable row marker
- Replaceable, reversible plow share blades
- UHMW (replaceable) poly lined bed press
- Spring loaded shovels on side, help loosen soil for cover disk
- Category II, 3-point hitch

Options

- Automatic steering correction (Ro-trak) for hill sides
- Hydraulic cover disk adjustment
- Single or double drip attachment
- Crowned bed press for level fields
- Center fillers, to help fill center of bed
- 400 lb. Stainless steel ground driven fertilizer hopper
- Fumigation tank mounts with gas knives

Want to see it work before buying?

Ask about our demo and rental units.

ITEM #	DESCRIPTION	PRICE
RAI2570	Rain Flo 2570 Mulch Layer W/ Auto Ro-Track	6000
RAI2670	Model 2670 Raised Bed Layer w/Auto Ro-trak	6550

Model 2670 Raised Bed Layer w/Auto Ro-trak



- 64" row centers with 4' plastic, 70 hp FWD minimum
- Adjustable plastic width from 3 ft. to 5 ft. wide plastic
- Adjustable bed height from 5" to 9" high bed
- On the go cover disk adjustment
- Adjustable brake tension on plastic roll carriers
- Bed press has adjustable side press plates
- With operator seat
- Adjustable row marker
- Replaceable, reversible plow share blades
- UHMW (replaceable) poly lined bed press
- Spring loaded shovels on side, help loosen soil for cover disk
- Category II, 3-point hitch

Options:

- Automatic self steering Ro-trak for hill sides
- Single or double drip applicator
- Crowned bed press for level field
- Center fillers, to help fill center of bed
- 400 lb Stainless Steel ground driven fertilizer hopper
- Fumigation tank mounts with gas knives

Description:

- Manual without Auto Ro-Trak deduction
- Drip attachment
- Double drip attachment
- Center of bed fillers
- Crowned bed
- Dry fertilizer hopper, 400 lb ground drive



Rain-Flo Flat Bed Mulch Layer

- Will lay 3' - 5' plastic; minimum 58" row spacing
- Requires minimum 35 hp with 4-wheel drive
- On the go cover disk adjustment
- Has extra plastic roll carrier
- 16" cover disks with dirt shields
- Compact machine has category I, 3-point hitch
- Lays clear plastic over sweet corn
- Has adjustable row markers
- Adjustable tension brake on plastic roll carriers.
- Independent disk and press wheels

Options

- Optional depth wheels (for sweet corn)
- Optional single or double drip applicator

ITEM #	DESCRIPTION	PRICE
RAI2370	Flatbed mulch layer	\$2,900.00

Rain-Flo Plastic Mulch Layer

- 60" row centers, 80 hp FWD Minimum
- Adjustable bed height; 4" or 8"
- Lays 48" plastic only
- Automatic steering correction (Ro-trak)
- Automatically starts standard plastic film
- Manual plastic & drip tape cutters
- On the go plastic roll change & cover disk adjustment
- Adjustable crowned or flat bed top
- Adjustable brake tension on plastic roll carriers
- Adjustable row markers
- Category II, 3-point hitch
- With operator seat
- Replaceable, reversible plow share blades
- UHMW (replaceable) poly lined bed press
- Options
- Optional depth wheels (for sweet corn)
- Optional single or double drip applicator

ITEM #	DESCRIPTION	PRICE
RAI480	48" with Auto Ro-Trak	\$7,900.00



Compact Raised Bed Layer

RB 436

- Lays 3' wide plastic with 4" high and 20" wide bed.
- 25-30 hp required

RB448

- Lay 3' or 4' plastic with 4" high and 20 or 30" wide bed.
- 30-35 HP required.

ITEM #	DESCRIPTION	PRICE
RB436	Call for more info	\$1,570.00
RB448	4' x 4" Raised Bed Layer	2157.48
RBA1	RB448 Single Drip Tape Attachment	186.33
RBA2	RB448 Double Drip Attachment	310

Mulch Plastic

White on Black Micro-embossed Film

52% Reflective, Decreases soil temperature while providing a strong weed barrier. Great for heat sensitive crops.



ITEM #	LENGTH	MIL	LBS	PRICE	16+
WB4241	4' x 2400'	1.25	60	126.46	\$123.93
WB44	4' x 4000'	1	80	163.58	\$165.25
WB54	5' x 4000'	1	96	205.34	\$207.44

BIO GOLD Black Embossed Biodegradable Film

In looks and lays like standard mulch plastic. No special laying instructions. No special storage instructions. BioGold relies on the microbes in the soil to bio degrade the plastic. BioGold is light and heat stable. BioGold is designed for one crop After harvest just disc BioGold into the soil BioGold will continue to degrade until just soil is left. Save time and labor and the environment.



ITEM #	COLOR	LENGTH	MIL	LBS	PRICE	16+
BBF45	Black	4' x 5000'	.6	58	204.96	\$200.86
BBFW45	Black/White	4' x 5000'	.8	70	\$331.98	\$325.34

Metalized Aluminum on Black

Reflective color gives insect protection. With 8" wide black Strip in center. Keeps heat reduction to minimum. **Can Be Shipped UPS.**

ITEM #	LENGTH	MIL	LBS	PRICE
SE44	4' x 4000'	1	60	211.84

Red Micro-embossed Film

Warms soil slightly faster than black, tests show increased yields in tomato and pepper plants, with glossier fruit. Colorfast. This is a premium red film.



ITEM #	LENGTH	MIL	LBS	PRICE
SRM4241	4' x 2400'	1.25	60	139.85

Green Embossed Film

Heats the soil faster during the day and retains more throughout the night. Use on early crops only.



ITEM #	LENGTH	MIL	LBS	PRICE	16+
GE4241	4' x 2400'	1.25	60	129.35	\$124.68
GE44	4' x 4000'	1	80	168.2	\$162.07

Clear Embossed Film

Though not as good as black for a weed barrier, the clear film will create more heat earlier.

ITEM #	LENGTH	MIL	LBS	PRICE	16+
CE44	4' x 4000'	1	80	129.91	\$151.85
CE62	4' x 2000'	1	61	99.65	\$98.36
CE54	5' x 4000'	1	100	151.13	\$186.20

Black Poly Expert Plastic

This plastic is Poly Expert's blown embossed plastic mulch. This plastic will not hug the bed quite as good as cast film, but where it shines is in plastic removal after the season. It is a very stretchy film and is strong to resist tearing. **The 1 mil thickness is equal to most 1.1 mil plastics.**



ITEM #	LENGTH	MIL	PRICE	16+
BE44	4' x 4000'	1	123.6	\$123.00



Agricultural Film Division of SIGMA Plastics Group

Black Micro-embossed Film

A general-purpose mulch with superior weed control and warms the soil to give plants a quick start, giving high yields in quality crops. Retains moisture and works exceptionally well in a variety of climates and soils.

- This film is hot embossed and a softer film that stretches nicely over the bed.
- A reinforced and highly durable cast embossed film.
- Blocks weeds and prevents soil coming in direct contact with fruit and green vegetable.
- Cleaner produce, which means a higher market Price.
- Works exceptionally well in a variety of soil types and climates.
- This mulch is wind resistance and elastically, which makes it easier to apply and remove.

ITEM #	LENGTH	MIL	LBS	PRICE	16+
BEF34	3' x 4000'	1	58	89.95	\$95.99
BEF424	4' x 2400'	1	48	70.88	\$73.09
BEF44	4' x 4000'	1	80	116.67	\$121.81
BEF44125	4' x 4000'	1.25	98	145.84	\$152.27

ITEM #	LENGTH	MIL	LBS	PRICE	16+
BEF4415	4' x 4000'	1.5	116	175	\$182.72
BEF524125	5' x 2400'	1.25	72	\$129.67	\$127.08
BEF54	5' x 4000'	1	100	145.84	\$152.27

Reyfilm Bio – Biodegradable Mulch Film

Embrace the Future with Biodegradable Mulch Film!

Benefits:

- Effective: Same benefits of traditional poly mulch in a fully biodegradable format. Unlike traditional plastic mulch, biodegradable alternatives break down naturally in the soil.

- Zero plastic waste: biodegradable mulch eliminates the need to remove and dispose of mulch film at the end of the cycle.

- Cost-Efficiency: bio mulch is a cost-effective choice for forward-thinking farmers. Save on labor, time and money by eliminating mulch retrieval, tractor fuel and disposal costs.

Thanks to the versatility of the characteristics offered by the REYFILM BIO mulch family, these mulch films can be used in different environmental conditions, for numerous types of crops and at different times of the year. The recommendation and selection for each type of product will depend on these factors.

The duration of mulch in the field depends largely on environmental factors (rain, temperature, radiation and activity of soil microorganisms). In general, reyfilm bio products in 15 microns (0.6 mil) are used for cultivation cycles of 2 to 6 months, and for crops lasting 9 to 12 months, thicknesses of 18 to 20 microns (0.8 mil) are recommended. Finally, for crops that require durations longer than one year, thicknesses of at least 40 microns are recommended. Reyfilm Bio has more than 15 years of monitoring usage and degradation in a multitude of crops such as tomato, pepper, lettuce, asparagus, melon, watermelon, etc.

Reyfilm Bio → CO₂ + H₂O + biomass



ITEM #	DESCRIPTION	LENGTH	MIL	PRICE	16+
REYB484	Reyfilm, BL Biodegradable, 4'x4000', .6MIL	4' x 4000'	.6	208.62	\$207.13
REYB604	Reyfilm, BL Biodegradable, 5'x4000', .8MIL	5' x 4000'	.8	339.32	\$313.10
REYBW484	Reyfilm, BL/WH Biodegradable, 4'x4000', .6MIL	4' x 4000'	.6	239.08	\$212.74



Water Wheel Planter

Planting Wheels Spike Spacing Chart

24" SUPER WHEEL FOR SNAP-ON SPIKE						
Plant Spacing	8"	16"	22"	28"	40"	77"
Number of Spikes Per Wheel	12	6	4	3	2	1

26" SUPER WHEEL FOR SNAP-ON SPIKE						
Plant Spacing	6"	12"	17"	31"	45"	86"
Number of Spikes Per Wheel	18	9	6	3	2	1

30" SUPER WHEEL FOR SNAP-ON SPIKE								
Plant Spacing	5"	10"	14"	19"	27"	35"	51"	98"
Number of Spikes Per Wheel	24	12	8	6	4	3	2	1

RainFlo™ Model 1670 Water Wheel Planter

Features

- Approximate tractor size: 50 to 70 hp
- Will plant 60" row spacing (minimum)
- Field ready with one planting wheel
- Plants bare roots, pots, and plugs
- Capability of 8" to 36" row spacing and one to four planting wheels (Standard)
- Two 80 gallon tanks
- 18 tray capacity, 24 with top tray
- Quick change planting wheel setup
- Easy adjustment for comfort on seat and foot rest
- Large tires with highway bearings
- Side valve for washing hands
- Galvanized expanded metal trays

- Optional top tray
- Optional 3 and 4 seat with trays
- Optional trailer\3-point combination
- Quick fill (2" quick coupler connection)
- Top Tray
- Side Ladder
- Extra Seats With Extra Shelf Each
- Planting Wheels: 12, 15, 18, 24, 30, 36, 48 &
- Custom Size. Standard Spike is C.
- Wheels not standard spacing or spikes

Options

- Optional super wheel (spike changes to multiple sizes and spacings)
- Optional side ladder

ITEM #	DESCRIPTION	PRICE
RAIFL1670	3-point planter w/one planter wheel	\$3,050.00
	3-point & trailer combo planter w/one planting wheel	



See page for the Spike spacing info.

A	B	C-E	F
\$9.00	\$8.00	\$4.50	Welded Wheel Only

Planting Wheel Spike Sizing Chart

Width at top →	← 2" →	← 1½" →	← 1¼" →	← 1⅜" →	← 1" →	← 1" →
Length →	6"	5½"	4½"	4"	3½"	2½"
Base →	4"	3¾"	2⅝"	2¼"	2"	1¾"
Snap-On	# A 3" Pots	# B 2½" Pots	# C *Standard* 50 to 72 Count tray	# D 72 to 96 Count tray	# E 96 to 128 Count tray	# F Seeds <small>Welded wheels only</small>

Transplanters



Compact 3PT Model 1270 Planter w/wheel

Model 1270 Water Wheel Transplanter. The most versatile water wheel planter for planting vegetables into plastic mulch!

Standard Features

- Compact Water Wheel Transplanter w/ Category I and II 3- Point Hitch
- Recommended Tractor Size: 40 – 60 HP
- Field Ready w/ One Planting Wheel
- Plants Bare Roots, Pots, & Plugs
- Capability Of 8” – 16” Row Spacing & One Or Two Planting Wheels (Standard)
- Two 50 Gallon Water Tanks
- 10 Tray Capacity; 15 w/ Top Tray
- Will plant 62” Row Spacing (Minimum)
- Quick Change Planting Wheel Setup
- New Design Seat Adjustment; Easy On the Go Adjustment!
- Galvanized Expanded Metal Trays
- **Options** •
- Extra Top Tray
- Trailer\3-Point Combination

ITEM #	DESCRIPTION	PRICE
RAIFL1270	Compact 3PT Model 1270 Planter w/wheel	2800

Sprayers



Lawn, Garden, and Orchard Sprayer

IVA high pressure sprayers are the industry standard to crop sprayers. Built tough for long term usability and reliable service. Orchard sprayers are available as 3PT, Trailer, and Cart sprayers.



Sprayers can be custom built to your specifications. Due to the many variable options you can order we list here only some of the options available for each customizable category. Please contact us for more info.



Field & Pasture Sprayer

IVA high pressure sprayers are the industry standard to crop sprayers. Built tough for long term usability and reliable service. Orchard sprayers are available as 3PT, and Trailer sprayers.

Sprayers can be custom built to your specifications. Due to the many variable options you can order, we list here only some of the options available for each customizable category. Please contact us for more info.



Produce Sprayers

IVA high pressure sprayers are the industry standard to crop sprayers. Built tough for long term usability and reliable service. Orchard sprayers are available as 3PT, and Trailer sprayers.

Sprayers can be custom built to your specifications. Due to the many variable options you can order, we list here only some of the options available for each customizable category. Please contact us for more info.



2 Row Shielded Sprayer

3 Point, 2 Row Shielded Row Sprayer, Cat 1, w/12 volt 50psi 4.8 gpm pump, 55 gal tank

ITEM #	PRICE
SUPSA3	2800

Fill out the forms on pages 115-117 and send them to us for a quote on an IVA sprayer.

Electric Sprayers

Back by popular demand!

Easy to use and designed to last, the Mercury trigger sprayer from Kwazar is much more than a spray bottle. Available in liter and half liter sizes, these high-quality sprayers have unique features making them perfect for precise plant treatments. Mercury sprayers include a unique double action spray head for a constant, fine spray with minimal effort! In addition, the 360° feature means that you can spray at any angle ... even upside down! The sprayers are ideal for tending indoor plants, spraying, foliar fertilizing, applying leaf shine, etc...



FEATURES

- 360° Spraying
- Double Action Trigger is easy on the hands
- Heavy Duty Base Ring for stabilization and protection
- Visible Fluid Strip to monitor fluid level
- Adjustable Spray Nozzle

ITEM #	DESCRIPTION	PRICE
KWAMER.5	.13 GAL (.5 Liter) Mercury Dualpump Sprayer	14.59
KWAMER1	.25 GAL (1 Liter) Mercury Dualpump Sprayer	16.67

Venus Super 360°

handheld pump sprayers come in 1.0L, and 2.0L capacities. These easy to use and durable sprayers are ideal for home, garden, and greenhouse use. The 360° feature means that you can spray at any angle ... even upside-down! Venus sprayers come with a directional and adjustable nozzle tip, a base rim for stability and protection, and visibility strip to check fluid level. There is also a built-in safety valve that operates in pressure exceeding 3 bar.



HIGHLIGHTED FEATURES

- 360° Spray Action
- Adjustable Spray Nozzle
- Comfortable Handle
- Pressure Control Safety Valve
- Heavy Duty Base Ring for stabilization and protection
- Visible Fluid Strip to monitor fluid level

ITEM #	DESCRIPTION	PRICE
KWAVEN	.25 GAL (1 Liter) Venus Handheld Sprayer	33.82
KWAVEN02	.50 GAL (2 Liter) Venus Handheld Sprayer	37.69

HIGHLIGHTED FEATURES

- Fingertip levers control direction and volume.
- Comfortable cross-shoulder strap.
- Fully enclosed gearbox is corrosion resistant.
- Large opening allows easy filling and cleaning.
- 20-lb.-capacity hopper with cap protects operator from chemicals and dust.



ITEM #	PRICE
SOL421	67.14

421 Multi-purpose Chest-mount Spreader

Designed for spreading a variety of granular material over irregular terrain, this chest-mount, extremely portable precision spreader is perfect for use in decorative beds with fertilizers and insecticides. Ideal for lawn maintenance, treating parking lot islands, as well as deer plotting. Eliminates banging over curbs with cumbersome wheeled units. The 421 spreader is also effective in spreading ice melt, oil absorbents and seeds.

425 Solo Backpack Sprayer

Rugged SOLO® backpack sprayers are flexible and ergonomically designed for virtually any spraying task both large and small with Fertilizers, Insecticides, Fungicides, Herbicides, Pest control, Disinfectants Built for comfort. Built for convenience. Built to last. SOLO's ergonomic design contours to your back for greater comfort. With a proven piston pump, you will be reliably equipped for applying spray liquid or insecticides in your garden. A low number of wearing parts and sturdy technology ensure a long service life and minimum maintenance. The SOLO® 425-101, with a connecting rod-actuated piston pump, can produce a wide pressure range of up to 90 psi and is capable of performing virtually every spraying task. Easily and effectively handles liquid disinfectants, fertilizers, herbicides, pesticides and formulations for tree, shrub and plant protection.



HIGHLIGHTED FEATURES

- Designed with professional features throughout.
- High-performance piston pump for increased pressure capabilities of up to 90 psi.
- Extra-large carrying handle with wand retainer for easy portability and storage. Deluxe shoulder straps and waist belt for user comfort.
- Rugged metal frame for stability when filling.
- Extra-large tank openings for easier filling and cleaning.
- 28" Unbreakable wand and shut-off valve for excellent reach.
- Commercial shut-off valve with lock-on/lock-off feature to minimize user fatigue.
- Viton® seals in key locations ensure long service and durability.
- Fold-away handle with wand retainers for easy storage and transport
- 48" nylon-reinforced high-pressure hose for extended reach.
- Double filtration system: filter basket and nozzle filter.
- Upgraded four-nozzle assortment for multiple spraying tasks: durable, professional grade, brass adjustable nozzle; fan spray; hollow cone; and jet stream nozzles. Tee Jet® compatible.

ITEM #	PRICE
SOL425101	84.28

466 MIST BLOWER

The new Solo 466 Mist Blower is ideal for applying plant protection chemicals, or for mosquito, pest and parasite control in storage areas, containers, or animal herds.

It is particularly popular in vector control especially in subtropic and tropic regions due to the new ULV nozzle 49480 that produces very fine droplets, applying chemicals over large areas more efficiently than manual spraying.

The striking design of the mister fan housing integrates all functional components such as starter, fuel tank, spark plug, air filter and carburetor and provides the SOLO 466 Mist Blower with an unmistakable appearance.



HIGHLIGHTED FEATURES

- New high-performance, low emission 66.5 cc 2-stroke engine to generate a fan air volume of max. 824 cfm for total plant penetration.
- Aluminum crankcase and high quality engine components for increased power output even under high temperature operating conditions.
- Increased engine performance converts to higher misting performance.
- Improved fuel efficiency and reduced emissions with modern engine technology and catalytic converter.
- Large 0.37 gallon capacity fuel tank combined with low fuel consumption allow long operating periods.
- Easy starting, fuel pump assisted.
- Effective vibration dampening.
- Single multi-function operating handle for throttle, spray volume and start/stop.
- Efficient air filtering system, easy to maintain.
- Ergonomically shaped and padded tank frame, comfortable, wide, padded shoulder straps and large, padded hip belt for superior operator's comfort.
- Compact size, low weight.
- Sturdy frame with integrated carrying handle and stand.

ITEM #	PRICE
SOL466	567.91

456 Professional Handheld Sprayer, 2.25 Gallon

These extremely heavy-duty sprayers will stand up to the toughest of jobs. Suitable for plant protection chemicals, pest control solutions and many other uses.

HIGHLIGHTED FEATURES & BENEFITS

- Viton® seals in key locations for durability and safety with a wide variety of chemicals.
- Large base for added stability. 458 model can accommodate the wheel set and pull handle (accessory kit, part # 49211).
- High-density polyethylene (HDPE) tank with ultra-violet inhibitors; will not dent, crack, or corrode.
- 48" nylon-reinforced hose for extended reach.
- Large piston pump pressurizes the sprayer as much as 50% faster than competitive sprayers.
- Automatic pressure relief valve releases pressure at 45 psi and may be used to release pressure manually when desired.
- 28" unbreakable wand and commercial shut-off valve assembly.
- Four-nozzle assortment for multiple spraying tasks: plastic adjustable, fan spray, hollow cone, and jet stream nozzles. Accepts Teejet® type nozzles.
- 4.5" opening allows easy filling and thorough cleaning.
- Extra large pump handle with built-in wand retainer for convenient carrying and pumping while wearing gloves.
- Commercial shut-off valve with lock-on/lock-off feature reduces user fatigue.
- 5-year commercial warranty against defects in material and workmanship.



ITEM #	PRICE
SOL456	\$49.05

475 Professional Backpack Sprayer

Built for comfort. Built for convenience. Built to last. SOLO's ergonomic design contours to your back for greater comfort. A low number of wearing parts and sturdy technology ensure a long service life and minimum maintenance. The large filling aperture for convenient filling of the tank and smooth-running pump make spraying pleasant work. The SOLO® 475-101 is capable of producing up to 60 psi, with its rugged connecting-rod-actuated diaphragm pump. The diaphragm is made of top quality material for its resistance to harsh chemicals and its long life expectancy. Designed with the ability to pass small abrasive particles without damage to the pump assembly. The diaphragm pump is ideal for handling chemicals in wettable powder form, as well as liquid formulations.

HIGHLIGHTED FEATURES

- Designed with professional features throughout.
- High-performance diaphragm pump for use with wettable powders, liquid and bleach solutions. Passes small abrasive particles without damage to the pump assembly. Produces pressure of up to 60 psi.
- Extra-large carrying handle with wand retainer for easy portability and storage.
- Deluxe shoulder straps and waist belt for user comfort.
- Rugged metal frame for stability when filling.
- Extra-large tank openings for easier filling and cleaning.
- 28" Unbreakable wand and shut-off valve for excellent reach.
- Commercial shut-off valve with lock-on/lock-off feature to minimize user fatigue.
- Viton® seals in key locations ensure long service and durability.
- Fold-away handle with wand retainers for easy storage and transport
- 48" nylon-reinforced high-pressure hose for extended reach.
- Double filtration system: filter basket and nozzle filter.
- Five-nozzle assortment for multiple spraying tasks: durable, professional grade, brass adjustable nozzle; plastic adjustable; fan spray; hollow cone; and jet stream nozzles. Tee Jet® compatible.



ITEM #	PRICE
SOL475	\$96.48

441 Battery-Operated Backpack Sprayer

Ideal for a variety of medium-to-large spraying jobs at home and on the farm, including general spraying, weed control, and gardening. Achieve optimal spraying coverage minus tiresome pumping with the 441's robust, lithium-ion battery..



HIGHLIGHTED FEATURES

- Speed Tip Nozzle: multi-spray pattern. Sprays with 3 different settings with a turn of the dial: jet stream, flat spray and full cone mist.
- 4 gallon, UV-resistant HDPE tank with large 4.75" opening. The large filter basket is easily removed.
- 11V diaphragm pump, 37.5 PSI
- 11V Lithium-ion Battery. 2.5 hours running time. 2-hour charging time
- Integrated carry handle for easy transport and maneuvering.
- Adjustable padded straps.
- 20" unbreakable wand provides excellent reach. The wand can be stored neatly in a wand holder, protected from dirt or damage by a special opening integrated in the tank base.
- Commercial shut-off valve with lock-on / lock-off feature reduces operator fatigue.
- 48" nylon reinforced high-pressure hose for extended reach.
- Stable tank base ensures that the sprayer will not tip over when filling.

ITEM #	DESCRIPTION	PRICE
SOL441	Solo Battery Herbicide Sprayer - 4 Gal	\$137.59



Wand for Solo Sprayer

Genuine Solo replacement parts. TeeJet® compatible. A step up in quality and function with an unbreakable 20-inch wand fitted to our commercial grade shut-off valve, a stainless filter screen, a plastic adjustable nozzle, and flat fan nozzle. ¼-inch and -inch hose barb adapts to virtually all sprayer brands. Solo's number 1 selling packaged accessory. Includes a stainless hose clamp.

ITEM #	PRICE
SOL64	\$20.47



Solo 20" - 36" Telescopic Sprayer Wand

ITEM #	PRICE
SOL18	43.2

Pump Rebuild Kit For Models 454 456 457



ITEM #	PRICE
SOL405K	\$41.53

Herbicide Shield



ITEM #	PRICE
SOL430	19.87

Solo Sprayer Piston Pump Rebuild Kit



ITEM #	PRICE
SOL060	18.06

Solo Wand Rebuild Kit



ITEM #	PRICE
SOL061	9.72

Rebuild Kit for Solo Diaphragm Sprayer



ITEM #	PRICE
SOL3	\$41.53



Fruit and Vegetable Packing Machinery

**CALL (☎) for Quote
And For Current Lead time**

- EARLY ORDER DISCOUNTS ! Items on THIS PAGE CALL for DISCOUNT Terms
 - First = 8% till Dec. 13/2024 - - Second = 4% till Dec. 30/2024 -



24" 4 Unit Packing line

which includes the following units :

- 1) Receiver Belt Conveyor,
- 2) Washer Brusher w/Electric Motor,
- 3) Sponge Water Absorber Repolisher,
- 4) 5' Rotary Table.

Excellent choice for growers that pack a variety of fruits or vegetables. It Washes , brushes and dries or dry brushes the produce then it can easily be sorted off the Rotary Packing table.

This line is powered with an electric motor on the Washer Brusher and Rotary Table.
 Total length of this 4 Unit Line 16'-7"
 All Lines can be powered with: Electric Motor, Gas Engine, or Hydraulic Motor.

Equipment Available in

24" 4PC PRICES PAINTED

- ELECTRIC = \$7,580.00**
- HONDA = \$7,345.00**

24" 4PC PRICES STAINLESS

- ELECTRIC = \$8,705.00**
- HONDA = \$8,490.00**



Stainless Steel or Painted Finish

Our entire product line (except for the Water Tanks) are available in both painted or T304 stainless steel (#4 polish finish). Water Tanks are only fabricated from stainless steel. Stainless equipment is solely stainless except for motors, gearboxes, sprockets, roller chain as well as some accessories. These items are also available in stainless upon request.

RBC RECEIVER BELT CONVEYOR



The smooth white rubber conveyer belt slowly feeds produce into the Washer (Brusher). This unit is normally powered by the Washer but can also be powered with it's own variable speed gear motor.

- 4' - Standard unit length
- 6' - 8' length is recommended if used with a Bin-dumper
- **CUSTOM** Lengths available
- Standard belt height is 32" to 38".
 RBC1604 = 20" W x 48" L
 RBC2404 = 28" W x 48" L
 RBC3204 = 36" W x 48" L
 RBC4004 = 44" W x 48" L
- Drive Options
 Drive off the Washer Brusher
 Drive with Gearmotor
 Drive with Variable Speed Gearmotor

RBC	Width (Inside) In Inches	Length In Feet	"S" =		Frame	Drive		
			Painted	Stainless		L3 = Off Washer (7.5 FPM)	01 = 1/2hp 110V Gear Motor (30FPM)	02 = 1/2hp 110V Variable Speed Drive
Painted Equipment								
RBC	16	04				\$1,000	\$1,660	\$2,115
RBC	16	06				\$1,115	\$1,770	\$2,230
RBC	24	04				\$1,045	\$1,700	\$2,160
RBC	24	06				\$1,170	\$1,820	\$2,280
RBC	32	04	-	2	L3	\$1,195	\$1,860	\$2,330
RBC	32	06				\$1,415	\$2,085	\$2,555
RBC	40	04				\$1,295	\$1,955	\$2,425
RBC	40	06				\$1,450	\$2,110	\$2,580
Stainless Steel Equipment								
RBC	16	04				\$1,345	\$1,985	\$2,445
RBC	24	04	S	2	L3	\$1,395	\$1,955	\$2,415
RBC	32	04				\$1,555	\$2,205	\$2,675
RBC	40	04				\$1,700	\$2,355	\$2,825

* Part numbers in Yellow Boxes must be used when ordering. For example: A 16 wide, 4' long, Painted, 1-1/4 frame, Low speed drive Part# RBC-16-04----2 L3=\$1000



Fruit and Vegetable Packing Machinery

CALL (☎) for Quote
And For Current Lead time

- EARLY ORDER DISCOUNTS ! Items on THIS PAGE CALL for DISCOUNT Terms
- First = 8% till Dec. 13/2024 - - Second = 4% till Dec. 30/2024 -

WB WASHER BRUSHER



- **Method of action**
Washes and brushes, or dry brushes the produce.
 - **BRUSHES (Bottom)**
Standard with 3 1/2" diameter nylon brushes with either soft or stiff bristles on plastic core.
Quantity; 10, 14, or 20 brushes
 - **BRUSHES (Top)**
Standard with 11" diameter nylon brushes with either soft or stiff bristles on plastic core.
Quantity; 1, 2, or 3 top brushes
 - **Produce size allowed**
The standard washer has 14" overhead clearance.
11" max produce with top brush installed
 - **Bearings**
Standard with Stainless Steel Sealed Ball bearings
or optional Zinc ball bearings, or UHMW Bushings
- Water pan to catch water and/or dust has 2" MPT drain port.
- **Powered by**
An electric motor, gas engine, hydraulic motor, or even an air motor can be used to power this unit and most of our complete packing lines.
 - **Water Supply**
Potable water supplied by standard garden hose (30 to 90PSI) & sprayed via Teejet nozzles
See chart for water usage

Top Brush

For a Brusher Washer

11" soft tufted brush to be installed in most high top washers. One, two, or three can be installed in one unit, depending on the model of the washer.

Ideal for: polishing; apples, pears, peaches, tomatoes, peppers, & more.



Cleaning:

Lettuce, bunches, squash, cantaloupes, gourds, turnips, potatoes, cucumbers, pumpkins, picking baskets, pails, ect.?

Consider using an AZS "Rinse Conveyor"

10-Brush Washer 38" long

16"W 24"W 32"W 40"W
4Noz. 6Noz 8Noz 12Noz
Gal. Per Min at 40 PSI.
2 Gal. 3 Gal. 4 Gal. 6 Gal.

14-Brush Washer 52" long

16"W 24"W 32"W 40"W
6Noz. 9Noz 12Noz 18Noz
Gal. Per Min at 40 PSI.
3 Gal. 4.5 Gal. 6 Gal. 9 Gal.

20-Brush Washer 73" long

16"W 24"W 32"W 40"W
8Noz. 12Noz 16Noz 24Noz
Gal. Per Min at 40 PSI.
3 Gal. 4.5 Gal. 6 Gal. 9 Gal.



WB + Length + Width	PAINTED with TOP BRUSH & Stainless Bearings		PAINTED with TOP BRUSH & Stainless Bearings		Stainless Steel with TOP BRUSH & Stainless Bearings		Brushes				
	E1 120V Elect.	E2 220V Elect.	G4 4hp Honda + mounting kit	E1 120V Elect.	E2 220V Elect.	.016 Green PSE Soft	N10 Blk Nylon Stiff Brush				
WB1016	-2S1BE1	120V Elect 1	\$2,815.00	-2S1BG4	4hp Honda	\$2,985.00	S2S1BE1	120V Elect 1	\$2,995.00	G16	N10
WB1024	-2S1BE1	120V Elect 1	\$3,220.00	-2S1BG4	4hp Honda	\$3,390.00	S2S1BE1	120V Elect 1	\$3,635.00	G16	N10
WB1416	-2S2BE1	120V Elect 1	\$3,385.00	-2S2BG4	4hp Honda	\$3,555.00	S2S2BE1	120V Elect 1	\$3,765.00	G16	N10
WB1424	-2S2BE2	240V Elect 1	\$3,835.00	-2S2BG4	4hp Honda	\$3,965.00	S2S2BE2	240V Elect 1	\$4,765.00	G16	N10

* Part numbers in [Yellow Boxes] must be used when ordering. Select Washer Base (WB1016) – Select Option Package (2S1BG4) – Select Brush (G16) For example: A 16" wide, 10B Washer, Painted, 1-1/4" frame, Stainless Bearings, 1 Top Brush, Soft Top Brush, 4Hp Honda, Soft Bottom Brushes = Part# WB1016 2S1BG4 G16 = 2985 call for additional sizes & options!

BWS BRUSH WATER SLINGER



- **Widths**
16", 24", 32", & 40"
 - **Method of action**
Brushes Water off fruits & vegetables
 - **BRUSHES (Bottom)**
Standard with 3 1/2" diameter nylon brushes with either soft or stiff bristles on plastic core.
Quantity; 10, 16, or 20 brushes
 - **Bearings**
Standard with Stainless Steel Sealed Ball bearings
or optional Zinc ball bearings, or UHMW Bushings
- Water pan to catch water and/or dust has 2" MPT drain port.
- **Powered by**
Connect to Washer Brusher or add Motor drive for stand-alone
An electric motor, gas engine, hydraulic motor, or even an air motor can be used to power this unit and most of our complete packing lines.

BWS + Length + Width	PAINTED with Stainless Bearings.		Stainless Steel with Stainless Bearings.		Brushes	
	-2S	S2S	-2S	S2S	.016 Green PSE Soft	N10 Blk Nylon Stiff Brush
BWS1016	-2S	\$1,540.00	S2S	\$1,790.00	G16	N10
BWS1024	-2S	\$1,765.00	S2S	\$2,075.00	G16	N10
BWS1616	-2S	\$2,180.00	S2S	\$2,505.00	G16	N10
BWS1624	-2S	\$2,545.00	S2S	\$2,945.00	G16	N10

Conveyors



Fruit and Vegetable Packing Machinery

**CALL (☎) for Quote
And For Current Lead time**

- EARLY ORDER DISCOUNTS ! Items on THIS PAGE CALL for DISCOUNT Terms
 - First = 8% till Dec. 13/2024 - - Second = 4% till Dec. 30/2024 -

RT05 ROTARY PACKING TABLE



- **Widths**
5Ft Diameter with entrance opening options; 16", 24", 32", & 40"
- **Method of action**
Moves produce around to people that are packing. Table speed is 2 1/2 rpm.
- **Table Surface**
White Plastic Cutting board
Cleans well with cleaners
- **Produce size allowed**
Not for 8lb or larger Items, Not for any leafy items
- **Powered by**
Powered by **110volt** gear motor // **1 speed** or **Variable** speed
Optional **belt driven** off the previous unit. Attaches to most of our packing lines.
Optional **Air** or **Hydraulic** driven

BWS + Length + Width	PAINTED		Stainless Steel		R = Rotary Table Drive To be installed on last unit	
	E1 = 120V Electric Mtr		E1 = 120V Electric Mtr		Painted	SS
	B1 = Belt Drive		B1 = Belt Drive			
RT0516	-2E1	\$1,550.00	S2E1	\$1,600.00		
RT0524	-2E1	\$1,550.00	S2E1	\$1,600.00		
RT0516	-2B1	\$980.00	S2B1	\$1,030.00	\$170.00	\$175.00
RT0524	-2B1	\$975.00	S2B1	\$1,030.00	\$170.00	\$180.00

SUB RUBBER BELT SIZING UNITS



- **Widths**
16", 24", 32", & 40"
- **Length**
32" Long per sizing unit
- **Method of action**
Drops round produce (smaller than hole in belt) through belt
Discharges sized produce out the side. Via gravity tray or powered belt
Larger produce continues to next sizer or else in the line
- **Produce size allowed**
Max belt hole of 3-1/2"
- **Powered by**
Powered by **110volt** gear motor // **1 speed** or **Variable** speed
Optional **chain driven** off the previous unit. Attaches to most of our packing lines.
Optional **Air** or **Hydraulic** driven



Square hole belts and hex sizing chains provide greater accuracy

SHC RUBBER CHAIN SIZING UNITS

Hex Chain Sizing Units



Shown with Side Packing Tables



NEV hex chain sizer with rubber coating chain - less marking on tomatoes!

- **Widths**
16", 24", 32", & 40"
- **Length**
40" Long per sizing unit
- **Method of action**
Same as belt sizer
- **Produce size allowed**
Max belt hole of 3-1/2"
- **Powered by**
Powered by **110volt** gear motor // **1 speed** or **Variable** speed
Optional **chain driven** off the previous unit. Attaches to most of our packing lines.
Optional **Air** or **Hydraulic** driven

Side Packing Tables

Poly slanted table that fits at side discharges on sizer units. Table top is HDEP polyethylene. Features spring-loaded lid on the bottom that opens to fill boxes.

Measurements:
 • 26 1/2" wide x 37 1/2" long
 • 23" to 29" discharge height



Spring-loaded lid in open position

Conveyors



Fruit and Vegetable Packing Machinery

CALL (☎) for Quote
And For Current Lead time

- EARLY ORDER DISCOUNTS ! Items on THIS PAGE CALL for DISCOUNT Terms
- First = 8% till Dec. 13/2024 - - Second = 4% till Dec. 30/2024 -

Misc Items		Standard Units	
Model		Description	
Bindumpers			
BD2002	-	low prof bindumper, JD Green	\$6,720.00
BD2002SS	S	low prof bindumper, Stainless Steel	\$10,415.00
Rinse Conveyors			
RC2410S-H10-B	S	Rinse Conv 24"W x 10' Stainless Steel	\$10,980.00
RC2410S-H20-B	S	Rinse Conv 24"W x 10' Stainless Steel	\$11,270.00
RC2410S-H31-B	S	Rinse Conv 24"W x 10' Stainless Steel	\$12,310.00
RX2410S-H10-B	S	Rinse Conv 24"W x 10' no motor Stainless Steel	\$7,585.00
RX2410S-H30-B	S	Rinse Conv 24"W x 10' no motor Stainless Steel	\$7,590.00
PC128-137G62P	-	Pump Cart with Dual Engine High Pressure & Circulation	\$4,260.00
RCHY2410S-H-B	S	Rinse Conv 24"W x 10' HYD drive Stainless Steel T304	\$10,885.00
Sweetcorn			
SCD425ASS	S	4Brush Sweetcorn Desilker 1/3HP (Optional 18VDC powered)	\$?



BD2002



BD3002



SCD425ASS

SCDA Series (4-Brush)
 • This unit removes silk as you feed the sweetcorn through. One person desilking can keep up with several people pulling off the husk.
 • 110V AC power. (use a GFCI receptacle)
 • Optional for 18V Milwaukee or Dewalt Several units being produce for trial.
 Measurements + Weight:
 • 31 1/2" x 8 1/2" x 18 1/2" • 65 lbs.

LIMITED Supply available



RCX2410S-H-PC128

Standard Model Choices:

- RC2410S-H10-B**
230V 1ph Electric
4GPM pressure Pump
- RC2410S-H20-B**
230V 1ph Electric
5.5GPM pressure Pump
- RC2410S-H30-B**
230V 1ph Electric
7GPM pressure Pump

RCX2410S-H-B with PC128
 Rinse conveyor washer with Airmotor on Conveyor
 4GPM pressure Pump & Circulation Pump on Cart with 13Hp Honda

RCHY2410S-H-B
 Washer with Hydraulic motors to run pumps & conveyor
 4GPM pressure Pump
 Circulation Pump

- High Pressure Rinse Conveyor**
- H10-**
Carrots, Beats // Loose or bunched
Kyle, Potatoes, Summer Squash, Tomatoes, Peppers, Cucumbers, Greens
 - H20-**
Carrots, Beats // Loose or bunched
Kyle, Potatoes, Summer Squash, Tomatoes, Peppers, Cucumbers, Greens, Cantaloupes, Watermelons, Radishes
 - H30-**
Carrots, Beats // Loose or bunched
Kyle, Potatoes, Summer Squash, Tomatoes, Peppers, Cucumbers, Greens, Cantaloupes, Watermelons, Radishes, Winter Squash, Pumpkins, & More



A24032G16L

Misc Parts			
SPONL387-062	16S=77	Sponge Latex 3-7/8od x 5/8" id x 1-1/2"	\$147.50
SPONL387-062	24S=112	Sponge Latex 3-7/8od x 5/8" id x 1-1/2"	\$213.75
SPONL387-062	Bx150	Sponge Latex 3-7/8od x 5/8" id x 1-1/2"	\$269.00
SPONL387-062	5+bx-150ea	Sponge Latex 3-7/8od x 5/8" id x 1-1/2"	\$254.00
A16032G16L	ea	Tufted Brushes 3-1/2" x 16" .016 Green PSE	\$40.75
A24032G16L	ea	Tufted Brushes 3-1/2" x 24" .016 Green PSE	\$62.00
A32032G16L	ea	Tufted Brushes 3-1/2" x 32" .016 Green PSE	\$77.75
A40032G16L	ea	Tufted Brushes 3-1/2" x 40" .016 Green PSE	\$105.75
NTF04	Sq Ft	Padding Self Adhesive 1/4" New Tuff Foam	\$5.60
NTF04	Fbx54"	Padding Self Adhesive 1/4" New Tuff Foam	\$21.40
PMPRTPD14	ea	Padding 1/4" Self Adhesive New-Tuff 2"W x 17 3/4" L For 5' RT	\$18.75
47M2SS	ea	Bearing Flange Stamped Steel 3/4" Stainless Steel	\$1.26
47M2ZP	ea	Bearing Flange Stamped Steel 3/4" Zinc	\$0.98
SB204-12-SS	ea	Sealed Bearing Insert 3/4" stainless	\$9.86
SB204-12	ea	Sealed Bearing Insert 3/4" Zinc	\$2.53
BU204-12U	ea	UHMW Bushing 204 x 3/4"	\$1.75
SPR40B1012	ea	NO 40B 10 Tooth Hardened 3/4" Bore	\$4.50
SPR40B1512	ea	Sprocket #40 15 Tooth 3/4" Finished Bore HT	\$5.75
SPR40B1812	ea	Sprocket #40 18 Tooth 3/4" Finished Bore HT	\$7.54
SPR40B4012W	ea	NO 40B 40 Tooth 3/4Bore Welda sprocket	\$18.20
SPR40103612	ea	NO 40 10& 36 Tooth Comb. 3/4Bore	\$13.88
SPR40153612	ea	NO 40 15 & 36 Tooth Comb. 3/4Bore	\$12.28
SPR40151612	ea	NO 40 15 & 16 Tooth Comb. 3/4Bore	\$13.25
SPR40161610	ea	#40 Double 16 tooth Idler Sprocket / w/ bearings	\$19.46
SPR40117E08	ea	NO40 17 Tooth idler Sprocket 1/2"	\$13.75
RC40	Ft	No 40 Roller Chain	\$1.50
CL40	ea	No 40 Connecting Link	\$0.34
OL40	ea	No 40 Offset link	\$0.70

Conveyors

Aluminum Harvesting Conveyor

Aluminum conveyor is designed for harvesting vegetables including: melons, sweet corn, pumpkins, broccoli, cabbage and cauliflower.



- Great for packing in bins, boxes or loose on the wagon. Mounts left or right and anywhere from front to rear of a regular farm wagon.
- Stand is 16" high and sits on one edge of the wagon. Opposite end clamps to wagon with two adjustable chains & C-clamp.
- 3.5' long fiberglass receiving and grading table.
- 3/4" PVC cleats on belt. Belt travels approximately 50' per minute.
- UHMW conveyor bottom for extended belt life.
- Easily put on or taken off in minutes.
- Includes two 20' long 3/8" hydraulic hoses and a low speed, high torque hydraulic motor.
- Painted aluminum side prevents discoloration of produce upon contact with side.
- Optional: Drop lid: removable lid allows produce to fall directly into crates, bins or boxes.
- Gasoline engine: for use with horse drawn wagons or where no hydraulic is available.
- **Now comes with a winch on the wagon end so you can adjust the other end up or down depending on your height desires.**

Please note: there is a 5% crating & handling charge if shipped. May not be in stock all the time...please call before picking up. Don't forget - you need a track row every eight rows of produce.

ITEM #	DESCRIPTION	PRICE
AHC28W	Hyd Drive 28' Conveyor (w/Winch)	2681.84
AHC50	Drop Lid Installed on New Conveyors	\$100.00
AHC55	30" Adjustable Extension Legs	\$115.00

Hyd Drive Brusher for Conveyor, 4x24" Brush

Optional hydraulic driven brushes (4 - 24") Helps speed cleaning in the field) for AHC28 Hyd drive only



ITEM #	DESCRIPTION	PRICE
AHC4	Hyd Drive Brusher for Conveyor, 4x24" Brush	\$2,675.00

Mulch Lifters

Rain-Flo Challenger 1800 Mulch Lifter

Standard Lifter - Auto-Reset Lifter

After your vegetable crop is over, the Challenger is designed to retrieve the plastic mulch to the surface of the ground. Will lift any plastic 36" to 60" with fast and easy adjustments. Lifting plows use standard Case IH 18" deep suck shears. To keep from clogging, the machine has three spring loaded trash and vine cutting disks and depth control wheels for constant depth control. Durable construction with 5/8" shear bolts (Auto reset is optional and recommended for rocky fields). This year, hitch to a Challenger and let it do the work!

Call us about renting one before buying to see for yourself.

- Approximate tractor size: 55 to 100 hp
- Will lift plastics from 3 ft to 5 ft wide with fast and easy adjustments
- Has two spring loaded trash and vine cutting disks
- Removable center disc to cut plastic in middle
- Heavy shanks have 5/8" safety shear bolts. Auto-reset is optional
- The Challenger is built to last and make your job easier.



ITEM #	DESCRIPTION	PRICE
RAIFL820A	1800 Lifter - manual reset	\$2,500.00
RAIFL1800A	1800 Mulch Lifter w/Autoreset	3400
RAIFL18PS	Complete Set of Plow Shares for 1800 Lifter	58

Plastic Mulch Wrapper & Spool

24" reel holds up to 1200' of plastic and drip tape. Features quick-release end plate and tapered cone for convenient roll removal. Adjustable reel angle allows pulling plastic in from the side to roll trash off. Variable speed flow-control operated by tractor driver.

LIF250 extras

Includes platform and manual guide loop which allows second operator to control reel speed and plastic feed. Shrink-wrap holder to easily wrap full rolls before removing.

LIF250-10, this reusable reel will wrap up tubing, lay-flat or tape for easy storage till next season.



ITEM #	DESCRIPTION	PRICE
LIF250	Model 250 3-pt Wrapper	1452
LIF250-10	Reusable Spools	57.6

Bird Scare Products

Bird Scare Balloons

Elevate at least 2' above your crop and rotate colors for best results.



ITEM #	DESCRIPTION	PRICE	10+
BC10	Black Spot Balloon	8.28	\$8.49
BC11	Yellow Spot Balloon	8.28	\$8.49
BC12	White Spot Balloon	8.28	\$8.49

Bird Scare Tape

Red/Silver with a noisy crackle. 1.25" wide x 290' Long



ITEM #	PRICE	5+
BC5012	7.7	\$8.02

Mesh Bird Netting 17W & 42W

Easy ON and Easy OFF! Easy Fit's patented locking square mesh design is a snap to install and comes off easily. Square meshes lock in length and width ensuring proper installed dimensions every time. And when it comes time to harvest, simply retract the netting and store out of the sun in a dry, ventilated location and you'll be all set for next year. Easy Fit is perfect for hobby and weekend growers who plan on installing smaller volumes of net by hand or for large commercial operations that require a seasonal net that drapes well on support structures. Perfect for use as vineyard netting and blueberry netting, AviGard Easy Fit works 24/7 to keep birds out and lock fruit flavor in.



ITEM #	DESCRIPTION	PRICE	1000+
BRDNT17	17'W 3/4"x3/4" Mesh Bird Net	1.1	\$1.02
BRDNT42	42"W 3/4"x3/4" Mesh Bird Net	0.18	
BRDNT44	44'W 3/4"x3/4" Mesh Bird Net	1.27	\$1.23

ZON Tripod Extension Kit

2' Tripod Extension Kit



ITEM #	PRICE
ZON110	33.59

ZON Rotating Tripod

Rotating Tripod allows zon gun to rotate 60 degrees with each detonation. Birds are not so apt to ignore it, and noise will carry further.



ITEM #	PRICE
ZON109	129.02

ZON LP Gas Cannon

Scare Gun Standard with regulator to install on propane tank, precise valve for fine regulation of gas flow.



ITEM #	DESCRIPTION	PRICE
ZON100	Zon Mark 4 Scaregun	248.35

Programmable Timer

Timer programmable for automatic starts and stops each day. Uses 1AA battery.



ITEM #	DESCRIPTION	PRICE
ZON1080	Programmable Scare Gun (Timer)	109.03

Greenhouse Handtools & Supplies

Tomato Cages

Heavy Duty 36" High. Top ring is 16" in diameter. Bottom ring is 13" in diameter.



ITEM #	PRICE	100+	500+
TC36	\$7.95	\$7.55	\$7.16

Tomato Stake Twiner Wrapper

ITEM #	PRICE
TSTW	10.1



To Twine Box

To Tomato Stakes

Ultra Heavy Duty Twine

TW10 • Has 11,000' on a 10lb ball. Mainly used in greenhouses of multi-season.

TW3 • 3lb Tomato Twine 6300 ft. Quality #2100 white twine box has a belt loop.



ITEM #	DESCRIPTION	PRICE	4+	18+
TW10	Ultra Heavy Duty Twine, 11,000'	25.64	\$25.46	
TW3	3 lb Tomato Twine 6300'	6.97		\$5.93

Tomato J-Hooks

J Hook Tomato Truss supports the stem of a cluster of tomatoes, it hooks onto the twine at multiple areas on the hook and holds up the cluster to prevent stem collapse/damage.

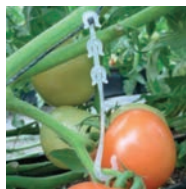

ITEM #	DESCRIPTION	PRICE
PVCJHK05	Pvc Tomato J-Hooks 500 CT	13.81
PVCJHK1	Pvc Tomato J-Hooks 1,000 CT	21.43
PVCJHK85	Pvc Tomato J-Hooks 8,500 CT	45.9

Vine Clips

These are used when growing tall plants, or vine crops to clip the plant to a string or trellis support wire. They are primarily used tomato, cucumber and pepper growers. Black PVC Vine Clips



ITEM #	DESCRIPTION	PRICE
PVC08	Blk Pvc Tomato Vine Clips 1,000 ct (23 MM)	17.23
PVC082	Blk Pvc Tomato Vine Clips 10,000ct (23 MM)	74.84

Tomato Twine Dispenser

ITEM #	PRICE
TW4	10.88



Heavy Duty Square Tomato Cages

13-1/4" x 13- 7/8" x 40" high. All galvanized steel, spot welded. Top Corners are rounded, excellent for use with row cover. Folds for ease of handling and storage. Double corner posts for greater strength & stability. Designed to go into soil 10", (up to first cross piece). Wire diameter: .205" Legs, .16" crosspieces.



ITEM #	PRICE	100+
TC13	13.49	\$12.60

Heavy Duty Collapsible Tomato Cages

A 14" x 40" or 14" x 48" tomato cage that folds twice for a very small compact size for very easy storage. They can be double stacked for additional height. The metal is a .143 gauge galvanized steel cage. It has 8 upright supports that insert into the ground for stability. A good sturdy cage for the price.

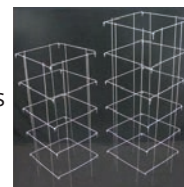

ITEM #	DESCRIPTION	PRICE	20+
TC40	14" x 40"	\$8.28	\$7.87
TC48	14"x48" Sq Collapsible Tomato Cage	10.52	\$10.79

2.0mm Tomato Grafting Clip

Grafting clips are made of soft and flexible silicon material with excellent light density. This material ensures easy grafting and prevents damage to the plants. Just squeeze and apply.



ITEM #	DESCRIPTION	PRICE	50+
GC2.0	2.0 MM Tomato Grafting Clip	0.09	\$0.07

3.0 MM Cukes and Watermelon Grafting Peg

Grafting Pegs are plastic with a metal ring used specifically for grafting cucumbers, melons, paprika and eggplant.



ITEM #	DESCRIPTION	PRICE	50+
GC3.0	3.0 MM Grafting Peg	0.13	\$0.10

18 Watt, AC Grow Lights

This 18W Red Grow Light is a flood style light that is screwed into a standard light fixture. It has 120 individual LED's per lamp. It has 78 red, 24 blue, 6 UV, 6 infrared and 6 white LED's per lamp to create the perfect light combination for flowering in a plant. The Blue light is for vegetative plant growth and it has 24 red, 78 blue, 6 UV, 6 infrared and 6 white LED's.



GROLI

ITEM #	DESCRIPTION	PRICE
GROLI	18 Watt, AC Red Grow Lights	58
GROLIB	18 Watt, AC Blue Grow Lights	\$58.00

Alliance Premium Rubber Bands Grade A



ITEM #	SIZE	QTY	VEGETABLE	PRICE	25+
BAN1R	4.5" x 3/16"	200	Cauliflower	6.5	\$5.54
BAN1G	4.5" x 3/16"	200	Cauliflower	6.5	\$5.54
BAN1Y	4.5" x 3/16"	200	Cauliflower	6.5	\$5.54
BAN1B	4.5" x 3/16"	200	Cauliflower	6.5	\$5.54
BAN63	3" x 1/4"	380	Beets	4.95	\$4.61
BAN62	2 1/2" x 1/4"	450	Asparagus, Broc.	4.95	\$4.61
BAN33	3 1/2" x 1/8"	600	All Purpose	4.95	\$4.61
BAN32	3" x 1/8"	700	Indian Corn	4.95	\$4.61
BAN30	2" x 1/8"	1,150	Indian Fingers	4.95	\$4.61
BAN16	2 1/2" x 1/16"	1,800	Onions, Radish	4.95	\$4.61
BAN14	2" x 1/16"	3,000	Radish	4.95	\$4.61
BAN31	2 1/2" x 1/8"	850/lb		4.95	\$4.61

Trellis Netting Net

Trellis Netting is a strong and versatile polypropylene mesh designed for growers as a gentle and more efficient support which helps increase yields by providing greater exposure to sunlight and air circulation for climbing vegetables as well as a support for flowers. Due to its durability and practical natures, Trellis Netting is now being used by many agriculturalists and floriculturists. It is available in a variety of widths and mesh sizes and is easy to handle and install. Trellis Netting fully satisfies the requirements of a variety of growing techniques, both vertical and horizontal. The variety of sizes makes it ideal for either home gardeners or commercial growers.



BENEFITS

- Reduces installation labor costs
- Is inexpensive, rot and rust proof
- Provides better exposure to light and air
- Is aseptic, reducing pesticide costs
- Is resistant to UV rays and chemical agents
- Maximizes cultivation density
- Results in higher crop yields

ITEM #	SIZE	PRICE
TENTR36328	36" x 328'	36.72
TENTR363280	36" x 3,280'	167.65
TENTR48328T	48" x 328'	39.25
TENTR483280T	48" x 3,280'	165.33
TENTR79328T	79" x 328'	50.72
TENTR793280T	79" x 3,280'	273.51

The ProtekNet

The ProtekNet 25 gram insect net offers a complete crop protection against insects. The 25 gram mesh is the most popular solution against most insects and is suitable for all types of production.



Very versatile, it can be used in the field, large tunnels or greenhouses. The net can be installed directly on the plants or hoops for better results. This is a clear netting and has a light transmission of 89%

- Complete exclusion insect control netting for your crops.
- Highly effective against insects and birds.
- Minimal thermal effect, so it can be laid during summer time.
- Protects crops against weather damage.
- Run-resistant fabric.

Insects That the Netting Keeps Out

- Aphids
- Armyworm
- Brown Marmorated Stink Bug
- Cabbage Root Fly
- Carrot Rust Fly
- Chrysomelid
- Corn Borer
- Flea Beetles
- Japanese Beetles
- Ladybugs
- Leafhopper
- Leek Moth
- Nymph
- Onion Maggot
- Sawfly
- Seedcorn Maggot
- Spotted Wing Drosophila
- Squash Bug
- Swede Midge
- Tarnished Stink Bug
- Thrips
- Twospotted Spider Mite
- Wasp
- White Fly

ITEM #	SIZE	PRICE
PN83328	25 gr 83" x 328' BioThrip	300
PN83820	25 gr 83" x 820' BioThrip	\$635.24
PN14328	25 gr 14" x 328' BioThrip	547.98
PN14820	25 gr 14" x 820' BioThrip	1254.98

60 Gram ProtekNet

93% light transmission. Life span 3-5 yrs. Can be used under greenhouse curtains.

Protects against Armyworm, Brown Marmorated Stinkbug, Cabbage Root Fly, Chrysomelid, Corn Borer, Onion Maggot, Sawfly, Seedcorn, Spotted Wing Drosophila (not 100%), Squash Bug, Tarnished Plant Bug.

ITEM #	SIZE	PRICE
PN680328	60 gr 83" x 328' ProTekNet	341.29

Wonder Waterer

The Wonder Waterer is the highest quality nozzle around for watering seedlings. It's laser cut face plate creates a gentle, precise water pattern that won't disturb delicate seedlings. Ask around! You'll find that plug growers LOVE their Wonder Waterer



ITEM #	DESCRIPTION	PRICE
WW3	Wonder Waterer Complete	29.91
WW31	Face Plate for Wonder Waterer	6.96
WW32	Screen For Wonder Waterer	4.95
WW33	Filter Case w/screen for Wonder Waterer	6.94

Water Breakers

ABS plastic body with a stainless steel face plate. The 400 is for fast watering, drenching, etc. The 1000 has a soft pattern yet waters faster than the Wonder Waterer.

ITEM #	DESCRIPTION	PRICE
WW1000	1000 Redhead Water Breaker	12.82
WW750	750 Lemonhead Water Breaker	12.82
WW400	400 Blue Plastic Water Breaker	6.87
WW10001	1000 Orangehead Water Breaker	12.82



Orangehead has a Ultra Soft Spray like Redhead, but with a wider pattern.

In/Outdoor, Min/Max Digital Thermometer

This is a digital thermometer that keeps a record of the minimum and maximum temperatures throughout the night or day. It automatically resets itself at the same time every day depending on what time the batteries were installed.



ITEM #	DESCRIPTION	PRICE
MPSMINMAX	In/Outdoor, Min/Max, Digital Thermometer	15.86

Aluminum Thermometer

ITEM #	DESCRIPTION	PRICE
MPSPT	MPS Aluminum Thermometer	18.42



Jumbo 6" Rain Gauge

This Jumbo 6" Rain Gauge can be mounted on a post or it can be inserted into the ground. Features a 6" tube with easy to see measurements in tenth of a inch increments.



ITEM #	DESCRIPTION	PRICE
RAIGA	Jumbo 6" Rain Gauge	6.45

Dramm Metal Fan Nozzle

Fan Nozzle. Heavy duty metal. Ergonomic insulated grip. Lifetime guarantee.



ITEM #	DESCRIPTION	PRICE
GGA260	Metal Fan Nozzle	9.73

Dramm Water Timer

ColorStorm™ Water Timer. Mechanical water timer. Turns water off automatically. Up to 120 minutes. Lifetime guarantee.



ITEM #	DESCRIPTION	PRICE
GGA25	Dramm Water Timer	14.13

Dramm Revolver

Revolver™ Nine spray patterns. Quick-click pattern changing. Ergonomic insulated grip. Heavy-duty construction. Lifetime guarantee.



ITEM #	DESCRIPTION	PRICE
GGA250	Revolver Spray Gun	10.87

Small Water Breaker

ITEM #	DESCRIPTION	PRICE
170PL	Small Black Water Breaker	5.86



Shrink Wrap

Exceptional Strength and Super stretch retention.



ITEM #	DESCRIPTION	PRICE
SF5	5" x 1000' Shrink Wrap Hand Rolls	6.76
SF16	18" x 1500' x 47GA Shrink Wrap	14.86

Tie Wire Twister

ITEM #	PRICE
SKU148	6.78



Packing Tape

ITEM #	DESCRIPTION	PRICE	36+
TAP020	3M Packing Tape, 2" x 330'	2.74	\$2.68



Camlock Fittings



Camlock Fittings

ITEM #	DESCRIPTION	PRICE
QCA010	1" Part A Aluminum Camlock	3.59
QCD010	1" Part D Aluminum Camlock	6.98
QCF010	1" Part F Aluminum Camlock	3.73

ITEM #	DESCRIPTION	PRICE
QCPB007	3/4" Part B Poly Camlock	5.9
QCPF007	3/4" Part F Poly Camlock	2.48

Part A



ITEM #	DESCRIPTION	PRICE
QCA015	1-1/2" Part A Aluminum Camlock	3.82
QCPA015	1-1/2" Part A Poly Camlock	3.36
QCA020	2" Part A Aluminum Camlock	4.75
QCPA020	2" Part A Poly Camlock	3.58
QCA030	3" Part A Aluminum Camlock	7.71
QCPA030	3" Part A Poly Camlock	7
QCA040	4" Part A Aluminum Camlock	12.42

Part B



ITEM #	DESCRIPTION	PRICE
QCB015	1-1/2" Part B Aluminum Camlock	8.85
QCPB015	1-1/2" Part B Poly Camlock	8.97
QCB020	2" Part B Aluminum Camlock	10.77
QCPB020	2" Part B Poly Camlock	10.21
QCB030	3" Part B Aluminum Camlock	16.41
QCPB030	3" Part B Poly Camlock	16.48
QCB040	4" Part B Aluminum Camlock	20.57

Part C



ITEM #	DESCRIPTION	PRICE
QCC015	1-1/2" Part C Aluminum Camlock	9.37
QCPC015	1-1/2" Part C Poly Camlock	9.78
QCC020	2" Part C Aluminum Camlock	10.94
QCPC020	2" Part C Poly Camlock	10.8
QCC030	3" Part C Aluminum Camlock	19.16
QCPC030	3" Part C Poly Camlock	16.48
QCC040	4" Part C Aluminum Camlock	25.18

Part D



ITEM #	DESCRIPTION	PRICE
QCD015	1 1/2" Part D Aluminum Camlock	9.98
QCPD015	1-1/2" Part D Poly Camlock	8.69
QCD020	2" Part D Aluminum Camlock	11.68
QCPD020	2" Part D Poly Camlock	10.57
QCD030	3" Part D Aluminum Camlock	17.3
QCPD030	3" Part D Poly Camlock	18.41
QCD040	4" Part D Aluminum Camlock	22.56

Part DC



ITEM #	DESCRIPTION	PRICE
QCPDC015	1.5" Part DC Poly Camlock	8.88
QCPDC020	2" Part DC Poly Camlock	9.83
QCPDC030	3" Part DC Poly Camlock	14.58

Part DP



ITEM #	DESCRIPTION	PRICE
QCPDP015	1-1/2" Part DP Poly Camlock	11.91
QCPDP020	2" Part DP Poly Camlock	3.1
QCPDP030	3" Part DP Poly Camlock	4.93
QDP040	4" Part DP Aluminum Camlock	13.43

QCG Rubber Gaskets

For camlock fittings



ITEM #	DESCRIPTION	PRICE
QCG015	1-1/2" Gasket For Camlock	1.1
QCG020	2" Gasket for Camlock	1.1
QCG030	3" Gasket for Camlock	1.22
QCG040	4" Gasket for Camlock	1.63

Wire Ties



ITEM #	DESCRIPTION	PRICE
BT176	Wire Ties 1000 Bundle	23.11

Hand Planter

Plant seeds through plastic mulch. Can be used to plant: Beans, Pumpkins, Squash, Cucumbers, Zucchini, & Sweet Peppers



ITEM #	DESCRIPTION	PRICE
MGS01	Hand Planter	89.58

Row Marking Flags

4"x5" White flag on 30" wire; 100 count



ITEM #	DESCRIPTION	PRICE
FLG3045W	4" x 5" White Flags On 30" Wire 100/pck	13.5

Part E

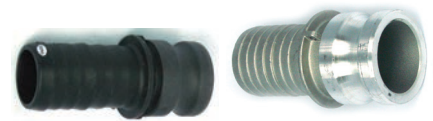

ITEM #	DESCRIPTION	PRICE
QCE015	1 1/2' Part E Aluminum Camlock	4.47
QCPE015	1-1/2" Part E Poly Camlock	3.71
QCE020	2" Part E Aluminum Camlock	5.92
QCPE020	2" Part E Poly Camlock	4.13
QCE030	3" Part E Aluminum Camlock	11.3
QCPE030	3" Part E Poly Camlock	7.54
QCE040	4" Part E Aluminum Camlock	17.58

Part F



ITEM #	DESCRIPTION	PRICE
QCF015	1-1/2" Part F Aluminum Camlock	4.99
QCPF015	1-1/2" Part F Poly Camlock	3.71
QCF020	2" Part F Aluminum Camlock	6.33
QCPF020	2" Part F Poly Camlock	4.18
QCF030	3" Part F Aluminum Camlock	10.95
QCPF030	3" Part F Poly Camlock	8.21
QCF040	4" Part F Aluminum Camlock	16.56

Watermelon Stickers / 1000/roll



ITEM #	DESCRIPTION	PRICE
WL4	Red Seedless Labels	\$22.76

Bulb Planter

Hand planter to plant almost anything. Works good to plant pots thru plastic.



ITEM #	DESCRIPTION	PRICE
MGS02	Bulb Planter	49.7

Plastic Tree Tags



ITEM #	DESCRIPTION	PRICE
PTL06	7" x 5/8" Plastic Tree Tag	40.5

Bags

This is the bag we use for our store. We put just about anything in this bag and it holds up very well! It will hold 12 ears of corn, 2 cantaloupes, 1 watermelon and various other produce. Customers that currently use this bag say they really like this tough bag. Made in the USA.



ITEM #	DESCRIPTION	PRICE	5+	20+
BAG1	Heavy Duty Smiley Bags 350/cs	32.76	\$30.69	\$29.73

12 Volt Sealed Battery



ITEM #	PRICE
MK12	28.99

EC Direct Soil Tester

The HI98331 Soil Test™ is a pocket tester specifically designed to directly measure soil conductivity (EC) and temperature. With a compact size, single button operation, and automatic calibration, Soil Test is an excellent choice for taking direct conductivity measurements in soil. No need for soil slurries with the steel penetration electrode.

Integrated temperature sensor for automatic temperature compensation.

Great for environmental and agricultural testing.



ITEM #	PRICE
HANEC/DST	115.68

pH Test Kit



ITEM #	DESCRIPTION	PRICE
HANPHKIT	PH Meter Test Kit	51.27
HANPH4.01	4.01 PH Buffer for PH Meters	2.22
HANPH7.01	7.01 PH Buffer for PH Meters	2.22

Handheld Counter

Keep track of what you are counting up to 9,999.



ITEM #	PRICE
COO	4.98

Basemount Counter

ITEM #	PRICE
CO1	13.57

Heavy Duty Nebo Hoe

Looking for a hoe that works as hard as you do? Look no further than this high quality Amish made hoe. Sold hundreds and hundreds of these and customers repeatedly say they have never had a stronger hoe than this one.



ITEM #	PRICE
HDH	42.13



Plain wood 8 x 7/8"

Wood Plant Labels

ITEM #	DESCRIPTION	PRICE
WPL12	12" x 1.2" Wood Plant Labels	27.74
WPL082	8" x 7/8" Wood Plant Labels	24.45

Portable Refractometer

1. Brix scale range is 0 to 32%.
2. Automatic Temperature Compensation: 10°~30°
3. Accuracy: ±0.2%
4. Easy to use, place 2~3 drops of sample on the main prism, close the daylight plate and look through the eyepiece for brix reading.



ITEM #	PRICE
PORREF	23.49

Splash Guard Goggles



ITEM #	PRICE
SAF15	4.83

EC Meter

Features at-a-glance

- Waterproof
- Fast Automatic Temperature Compensation with exposed temperature probe
- Graphite sensors that reduce polarization effects
- 0.5 (500 ppm) and 0.7 (700 ppm) selectable EC to TDS conversion factors
- Single point automatic calibration using Quick Cal standard or 1.41 mS/cm in standard calibration mode
- 250 hour battery life



The HI98318 is our latest pocket meter for measuring the EC/TDS of a hydroponic nutrient solution. It is only 0.7" thick, fitting comfortably in your hand. The meter has a button for turning the meter on/off and another button for automatic one point calibration.

Automatic calibration is achieved easily. Simply submerge the sensor in calibration solution and the meter will automatically detect the calibration standard (5.00 mS/cm in Quick Cal mode or 1.41 mS/cm in standard calibration mode). Temperature is automatically compensated for with the integrated temperature sensor.

- High accuracy with 0.01 pH resolution
- Two point fast and accurate calibration
- Usable with virtually any electrode that shares the same connector
- 3000 hours of battery life
- HI 1270 small diameter probe fits easily into a test tube

ITEM #	PRICE
HANEC/PPM	79.53

6 MIL Nitrile Gloves

Synthetic nitrile rubber is resistant to oil, fuel, and other chemicals and the 6 mil ntxpand provides even more resistance than the regular 4 mil glove. In addition, the extra thickness has better tear and puncture resistance than thinner gloves, making it safer to use. The fingertips are lightly textured for better grip.



ITEM #	DESCRIPTION	PRICE
SAF5L	Disposable Large Nitrile Gloves 100 Ct	8.97
SAFXL	Disposable X Large Nitrile Gloves 100 Ct	8.97

Latex Coated Mesh Picking Gloves

Latex coated, mesh glove for a multitude of chores. One size fits all. Economically Priced. Mesh back for less perspiration. A glove for picking produce, pulling weeds, log splitting, and much more.



ITEM #	DESCRIPTION	PRICE
SAF10	Picking Gloves w/Black Cuff (Large)	1.61
SAF09	Picking Gloves w/Blue Cuff (Medium)	1.61

Farmer's Defense Arm Guard

Farmers Sleeves offer unparalleled protection of arms and skin for any farmer, gardener, or outdoor worker. Say goodbye to irritated skin and sunburns in the garden. Our sleeves offer cooling comfort and protection against the elements outdoors. These Farmers Sleeves are made from REPREVE® eco-dynamic fabric, made from recycled materials, with moisture-wicking qualities that keep you cool and dry.



Great for:

- Farming
- Gardening
- Landscaping

Offers:

- UPF 50+ protection against harmful UV rays
- Protection against skin allergens and scratches
- Alternative to thick clothing

ITEM #	DESCRIPTION	PRICE
FDPS/L	Farmers Defense Arm Guard, L/XL	16.84
FDPS/XXL	Farmers Defense Arm Guard, XXL	20.67

Tyvek Coveralls

Extra heavy duty, white, hooded



ITEM #	DESCRIPTION	PRICE
TCGO	Tyvek Coveralls Lg	11.78
TCG1	Tyvek Coveralls, X-Large	11.78

Nitrile Rubber Chemical Gloves

This is a 15 MIL, 13", Unlined chemical glove. Get broad-range chemical protection and a "second skin" fit from Nitrile gloves. Nitrile is 3 times stronger than latex.



ITEM #	DESCRIPTION	PRICE
SAF009	Green Nitrile Chemical Gloves L #10	4.74
SAF010	Green Nitrile Chemical Gloves XL #11	4.74
SAF011	Green Nitrile Chemical Gloves XXL #12	4.74

12" Rubber PVC Gloves

ITEM #	DESCRIPTION	PRICE
SAF12	Black Rubber Pvc Gloves 1 Pair	2.99





Vapor Respirator

ITEM #	DESCRIPTION	PRICE
M8001	Small Moldex Respirator Facepiece	27.51
M8002	Medium Moldex Respirator Facepiece	27.51
M8003	Large Moldex Respirator Facepiece	27.51
M8004	Replacement Cartridges for Moldex Mask	29.87

Super Clamps

Fits Lay-flat hose

ITEM #	SIZE	PRICE
SUPCLL015	1 1/2"	7.32
SUPCLL020	2"	3.83
SUPCLL030	3"	4.38
SUPCLL040	4"	5.35



Suction Hose Clamps

ITEM #	SIZE	PRICE
SUPCLS015	1 1/2"	4.32
SUPCLS020	2"	4.92
SUPCLS030	3"	6.54
SUPCLS040	4"	7.69



Untreated White Oak Wood Stakes

This quality stake can be used for several seasons. These untreated stakes are AIR DRIED white oak stakes. Air dried stakes have a lot of benefits over green stakes. They will not turn black from mold when stored, stay straighter in the field and are lighter in weight. Try some quality, air dried, stakes for yourself to see the advantages.

- 1" x 1" • 25/Bundle 1200/skid

ITEM #	DESCRIPTION	PRICE
TS36	36" Untreated White Oak Wood Stakes 25/bnl	16.61
TS48	48" Untreated White Oak Wood Stakes 25/bnl	20.51
TS60	60" Untreated White Oak Wood Stakes 25/bnl	27.61
TS72	72" Untreated White Oak Wood Stakes 25/bdl	27.97
TS84	84" Untreated White Oak Wood Stakes 25/bnl	37.11



Commercial Vegetable Recommendations Guide

Updated annually, this guide is intended to help commercial vegetable growers in the Mid-Atlantic region make managerial decisions on general production, soil and nutrient management, irrigation management, pesticide safety, pest management, and specific commodity choices.

picture not available

ITEM #	PRICE
MIDCOV	44.86

IDEAL Hose Clamps

A premium quality USA made screw driver clamp. Clamps are all stainless steel construction, no metal screw to rust. Heavy 9/16" band. 5/16" hex head with slot for flat screwdriver. 10 Clamps / box.



ITEM #	SIZE	PRICE
SSC005	1/2"	13.17
SSC007	3/4"	14.53
SSC010	1"	15.98
SSC015	1 1/2"	16.1
SSC020	2"	13.78
SSC030	3"	22.8
SSC040	4"	26.34

Untreated Hardwood Stakes 25/bnl



ITEM #	SIZE	PRICE
TS248	48"	18.32
TS63	60"	25.64

Treated Honduras Pine Stakes

This Quality stake can be used for several seasons. 1" x 1" 25/Bundle 1400/skid unless noted. 1.25" x 1.25" • 1050/skid • 25/bundle



ITEM #	SIZE	PRICE
TS148	48" x 1" x 1"	22.13
TS154	54" x 1" x 1"	25.29
TS160	60" x 1" x 1"	28.8
TS17252	72" x 1.25" x 1.25"	52.92

12" Heavy Duty Stainless Knife

12" Heavy duty stainless steel blade harvest knife is widely used for different crops in the field.



ITEM #	PRICE
DURK120	14.8

Garden Seeder, Plates & Storage Case

The ever popular seeder is used by home gardeners and produce growers, perfect seed spacing... easy to use...and best of all. Affordable! Includes 6 seed plates; corn, peas, beans, radish, carrots, and beets.

Six Plates include with Seeder: Sweet Corn, Peas, Beans, Radish, Carrots, Beets.



ITEM #	DESCRIPTION	PRICE
ERT06	Standard 7 Seed Plates	53.01
ERT05	Optional Seed Plates(5)	34.59
ERT04	Sweetcorn Seed Plate	12.27
ERT09	Cabbage-Lettuce Seed Plate	12.27
ERT10	Carrots, Lettuce, Turnips, Cabbage Seed Plate	12.27
ERT14	Beans, Small Peas Seed Plate	12.27
ERT18	Peas, Early June Peas Seed Plate	12.27
ERT22	Beets, Swiss Chard Seed Plate	12.27
ERT24	Cauliflower-Broccoli Seed Plate	12.27
ERT26	Cucumber Seed Plate	12.27
ERT29	Popcorn Seed Plate	12.27
ERT27	Lima Bean Seed Plate	12.27
ERT050	Radish, Leeks Asparagus, Spinach Plate	12.27

Stake Puller

This aluminum lightweight stake puller will save your back and a lot of time. Just engage it onto the stake and use it like a v handle. You will wonder how you did without it.



ITEM #	DESCRIPTION	PRICE
TSP	Tomato Stake Puller	97.29

Stake Driver



ITEM #	DESCRIPTION	PRICE
TSD1	Stake Driver	32.61

Soil Moisture Indicator

Your exact soil moisture at a glance. Helpful for irrigating any crops. Order the proper length meter to reach to the active root zone. Check your moisture at the root zone.



IRR0METER

ITEM #	DESCRIPTION	PRICE
IRR06	6" Long Irrrometer	87.3
IRR12	12" Long Irrrometer	112.71
IRR18	18" Long Irrrometer	116.48

ITEM #	DESCRIPTION	PRICE
IRR5	1001 Irrrometer Service Kit	79.32
IRR52	1004 Irrrometer Fluid, 1 Oz	6.24



What is most important when you want to purchase a product? Exactly, a good product for a good Price, good service from the producer and a satisfied feeling.



Guarantee

Metallo Tools provides 10 years of guarantee and spare parts for all products. [Read more.](#)

Pointed Pruner

Description: The pointed pruner works well to get into hard to get to areas to trim and will cut through up to 1/2" growth.



ITEM #	PRICE
METK0060	25.17

Pruner w/SK5 Steel Blade

Ergonomic design with squeeze to unlock feature. Blades are high carbon steel, hard chrome plated. Handles are aluminum to keep the unit light in weight. Cuts up to 3/4" diameter material. Spare parts are available.



ITEM #	PRICE
METK0050	26.65

Pruner w/SK3 Steel Blade

Ergonomic design with squeeze to unlock feature. Blades are high carbon steel, hard chrome plated. Handles are aluminum to keep the unit light in weight. Cuts up to 3/4" diameter material. Spare parts are available.



ITEM #	PRICE
METK0600	29.88

Pruner w/sk3 Steel Blade

Designed for a large hand. Forged steel design, cutting blades made with high carbon steel, hard chrome plated, aluminum handles with easy grip coating a two position lock system and ergonomic design. The upper blade is replaceable. Cuts material up to 1" in diameter.



ITEM #	PRICE
METK0500	28.14

Lopper w/Wooden Handle

Classic wooden handle bypass lopper. The blades are made of high carbon steel so they hold a sharp edge longer. The wooden handles have a built in rubber bumper stops to reduce shock load to hands and wrists while cutting. The overall length is 27.5" and the weight is just 2.7 pounds.



ITEM #	PRICE
METK5600	38.54

Solingen Knife w/Orange Handle

A very sharp, inexpensive produce cutting knife. Can be sharpened or just dispose to prevent spreading of diseases from one field to another. We have customers that use them for butchering, harvesting produce, or any other job on the farm.



ITEM #	PRICE
MET956019	1.28

Rounded Tip Solingen Knife w/Orange Handle

Very similar to the MET956019 knife. This Stainless Steel strip knife has a 1 3/4" blade and a round tip. This lightweight knife has a red plastic handle and can be used universally. Extremely suitable for harvesting bell pepper, cucumber and tomatoes. The rounded tip prevents damage to the plant or fruit.



ITEM #	PRICE
MET956013	\$1.28

Heavy Duty Pruning Scissors, Orange Handle

This scissors has a long pointy blade designed for multiple uses. Perfect for harvesting fruits and vegetables.



ITEM #	PRICE
METK0040	14.67

Pruner w/SK3 Steel Blade

Designed for a medium size hand with a one position lock system. Forged steel design, cutting blades made with high carbon steel, hard chrome plated with aluminum handles with an ergonomic design and a special easy grip coating. The upper blade is replaceable. Cuts material up to 3/4" in diameter.



ITEM #	PRICE
METK0400	27.2

Curved Hand Held Pruning Saw

Folding handle, professional grade, curved blade pull saw designed with a one button system for easy opening and closing. Saw blades are high carbon steel, hard chrome plated with hardened teeth using an impulse hardening process for long lasting sharpness. The saw has a coated grip and weighs only .6 pounds. The blade is 7" long, closed length is 9.5" and the overall length when open is 16.4". Replacement blades are available. Spare parts are available.



ITEM #	PRICE
METK6045	35.83

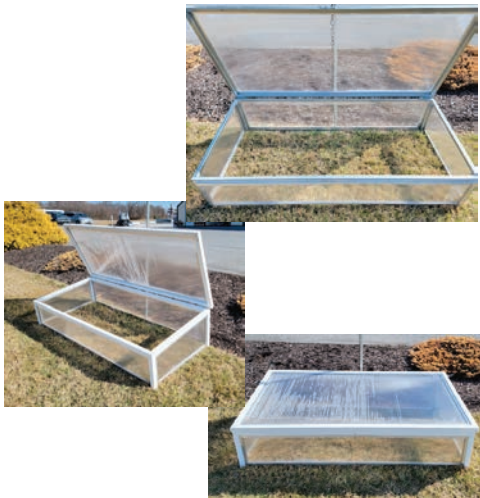

Metal Frame Polycarbonate Hot Bed

ITEM #	DESCRIPTION	PRICE
STOHOTBE	Metal Frame Polycarbonate Hot Bed 6' wide x 32" deep x 15" high	\$341.82

Poly Frame Polycarbonate Hot Bed

ITEM #	DESCRIPTION	PRICE
STOHOTBE	Poly Frame Polycarbonate Hot Bed 6' wide x 32" deep x 15" high	\$341.82



Vegetable Seed Planter

This is a max emerge 2 row vacuum planter set up for sweet corn. The vacuum is either run by a DC/AC inverter run off the tractor battery or a hydraulic pump run off of the hydraulic system. The vacuum planter is a lot more precise and accurate in seed placement for better population than a finger pickup. This planter can be set up for no till, liquid fertilizer, or set up for various other produce crops. We need to know what seed you are using then we can get the right plate for the job. If you need a custom planter we could set one up for your exact needs.



TATER Rip Tandem Plow

Adaptable & Adjustable for planting, hilling, and harvesting.

The TATOR Rip has two plow shanks to give you the adaptability you need to work with potatoes, sweet potatoes, carrots, peanuts, and other underground crops. Use both shanks for planting, hilling, and harvesting, or you may wish to use only one shank during harvest.



ITEM #	DESCRIPTION	PRICE
TDF442	Tater Rip Tandem Plow, 35HP and up	898.96

RoHand II

Plant, Maintain & Harvest your Produce efficiently and pain free!

- Robust speed control for soft start/stop and overheat protection.
- Foot-controlled variable speed and steering keeps both hands free for higher productivity
- Dual gear motors and cleated drive tires provide torque and traction for the most challenging field conditions
- Compact lithium ion battery for years of trouble-free service
- Fully adjustable operator platform and head support for all-day comfort.
- Four wheeled design adds stability and allows easy on/off access from both sides of the machine
- Storage for up to 7 strawberry flats
- Roll down shade protection from hot sun or rain
- The RoHand will now be on a 4' x 8' pallet for easier shipping!



CALL FOR PRICING



Proveyor Wagon EX 17

- 24' wagon bed with track on the side to move the conveyor from front to back
- The conveyor can be adjusted from 14" to 40" off the wagon with a hydraulic cylinder
- Hydraulic tilt to lower the end of the conveyor
- The conveyor can be run with the tractor's hydraulics or a separate hydraulic unit.
- 12" x 26" 10 ply low profile tires
- Spring loaded hose reel mounted under the wagon
- 8 ton Stolt wagon gear

OPTIONS AVAILABLE

- 20' to 30' wagon sizes
- Hydraulic rear steering
- Trailer style

CALL FOR PRICING

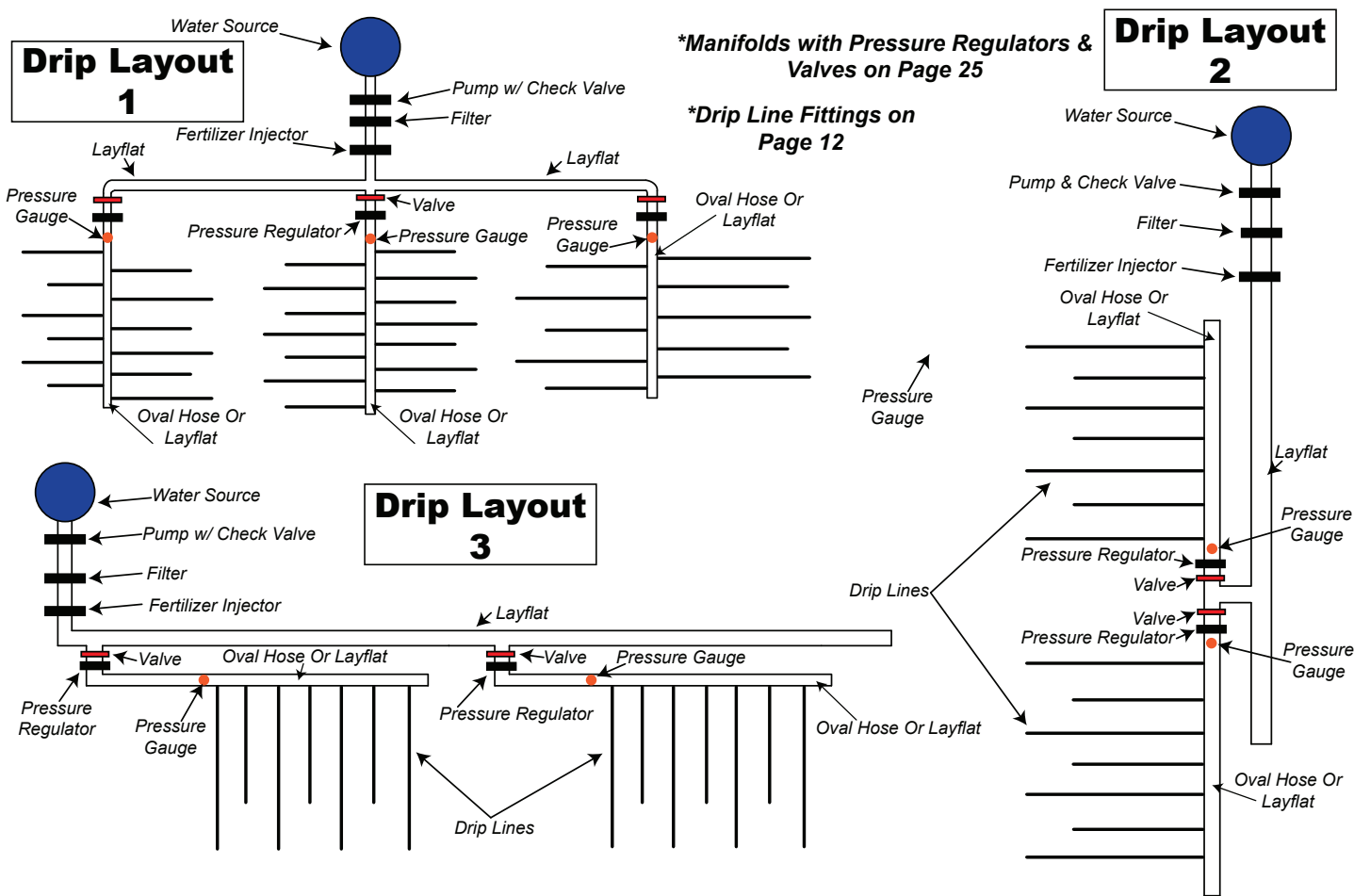

HANDY ELEVATION SCALE. CAN ALSO BE USED FOR WELL DEPTH.

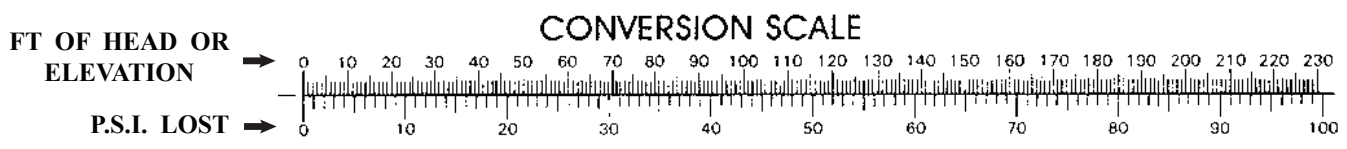

SURFACE WATER CHLORINATION

For best results; if using surface water, you should chlorinate your system every two weeks. Inject approximately ½ Gal. chlorine bleach per acre. Run system about 20 minutes then let set for ½ day before irrigating again.

Square feet per acre = 43,560 sq. ft.
 1 Acre = 208.71 ft. sq.
 1" an Acre = 6,500-13,500 Gallons (Drip irrigation depending on row spacing)
 1" an Acre = 27,154 Gallons (Overhead Irrigation)
 1" per hour an acre = 452.57 GPM (Overhead Irrigation)

Row Spacing (INCHES)	Plastic FEET PER ACRE
48"	10,890'
52"	10,052'
56"	9,334'
58"	9,012'
60"	8,712'
62"	8,431'
64"	8,168'
66"	7,920'
68"	7,687'
70"	7,467'
72"	7,260'
76"	6,876'
80"	6,534'
84"	6,223'
88"	5,940'

LAYFLAT FRICTION LOSS PER 100' PSI							
GPM	1 1/2"	2"	2 1/2"	3"	4"	6"	
20	1.2						
30	2.4						
40	5.1	1.1					
50	6.0						
60		2.4	1.4				
80		4.1	1.9	1.0			
90	17						
100		6.0	2.8	1.2			
120				1.8			
140				2.2			
160				2.6	0.6		
180				3.3	0.7		
200		22	7		0.8		
220					1.0		
250				5			
280					1.4	0.2	
300					1.6	0.2	
350			22				
380						0.4	
420						0.5	
460						0.6	
500					4	0.7	
580				22		0.9	
620						1.0	

Oval Hose Friction Loss and Velocity													
Size ID	1" Oval		1-1/4" Oval		1-1/2" Oval		2" Oval		3" Oval		4" Oval		
	Friction Loss	Velocity	Friction Loss	Velocity	Friction Loss	Velocity	Friction Loss	Velocity	Friction Loss	Velocity	Friction Loss	Velocity	
gpm	psi/100	fps	psi/100	fps	psi/100	fps	psi/100	fps	psi/100	fps	psi/100	fps	
2	0.16	0.75	0.04	0.43	0.02	0.32	0.01	0.19	0.00	0.09	0.00	0.05	
4	0.53	1.51	0.14	0.87	0.07	0.64	0.02	0.39	0.00	0.18	0.00	0.10	
6	1.08	2.26	0.29	1.30	0.14	0.96	0.04	0.58	0.01	0.27	0.00	0.15	
8	1.78	3.02	0.48	1.74	0.23	1.28	0.07	0.78	0.01	0.36	0.00	0.21	
10	2.64	3.77	0.71	2.17	0.34	1.59	0.11	0.97	0.02	0.44	0.00	0.26	
12	3.63	4.53	0.98	2.61	0.47	1.91	0.14	1.17	0.02	0.53	0.01	0.31	
14	4.75	5.28	1.28	3.04	0.61	2.23	0.19	1.36	0.03	0.62	0.01	0.36	
16	6.00	6.04	1.62	3.48	0.78	2.55	0.24	1.55	0.04	0.71	0.01	0.41	
18	7.38	6.79	1.99	3.91	0.95	2.87	0.29	1.75	0.05	0.80	0.01	0.46	
20	8.87	7.54	2.40	4.35	1.15	3.19	0.35	1.94	0.06	0.89	0.01	0.51	
25	13.11	9.43	3.54	5.43	1.69	3.98	0.52	2.43	0.08	1.11	0.02	0.64	
30	18.04	11.32	4.87	6.52	2.33	4.78	0.72	2.91	0.11	1.33	0.03	0.77	
35			6.38	7.61	3.05	5.58	0.94	3.40	0.15	1.56	0.04	0.90	
40			8.06	8.70	3.86	6.38	1.19	3.88	0.19	1.78	0.05	1.03	
45			9.90	9.78	4.74	7.17	1.46	4.37	0.23	2.00	0.06	1.15	
50			11.91	10.87	5.70	7.97	1.76	4.85	0.27	2.22	0.07	1.28	
60					7.84	9.56	2.42	5.83	0.38	2.67	0.10	1.54	
70					10.27	11.16	3.16	6.80	0.49	3.11	0.13	1.79	
80							4.00	7.77	0.62	3.56	0.17	2.05	
90							4.91	8.74	0.77	4.00	0.21	2.31	
100							5.91	9.71	0.92	4.44	0.25	2.56	
110							6.98	10.68	1.09	4.89	0.30	2.82	
120									1.27	5.33	0.34	3.08	
130									1.46	5.78	0.40	3.33	
140									1.66	6.22	0.45	3.59	
150									1.88	6.67	0.51	3.84	
175									2.46	7.78	0.66	4.48	
200									3.10	8.89	0.84	5.13	
225									3.82	10.00	1.03	5.77	
250									4.59	11.11	1.24	6.41	
300											1.71	7.69	
350											2.24	8.97	
400											2.83	10.25	

Grey boxes: Velocity above 5 fps is not recommended.

SDR 21 FRICTION LOSS PSI/100' / FLOW VELOCITY FT/SECOND														
GPM	1 1/2"		2"		3"		4"		5"		6"		8"	
25	1.25	3.53	.42	2.25	.06	1.03	.02	.62						
30	1.75	4.24	.59	2.70	.09	1.24	.03	.75	.01	.49				
35	2.33	4.94	.78	3.15	.12	1.44	.03	.87	.01	.57				
40	2.99	5.65	1.00	3.60	.15	1.65	.04	1.00	.02	.65				
45	3.72	6.36	1.24	4.05	.19	1.86	.05	1.12	.02	.73				
50	4.52	7.06	1.51	4.50	.23	2.06	.07	1.25	.02	.82	.01	.58		
60	6.33	8.48	2.12	5.41	.32	2.48	.09	1.5	.03	.98	.01	.69		
70	8.42	9.89	2.82	6.31	.42	2.89	.12	1.75	.04	1.14	.02	.81		
80			3.61	7.21	.54	3.30	.16	2.00	.06	1.31	.02	.92		
90			4.49	8.11	.67	3.71	.20	2.24	.07	1.47	.03	1.04		
100			5.46	9.01	.82	4.13	.24	2.49	.09	1.63	.04	1.15	.01	.68
125					1.23	5.16	.36	3.12	.13	2.04	.06	1.44	.02	.85
150					1.73	6.19	.51	3.74	.18	2.45	.08	1.73	.02	1.02
175					2.30	7.22	.68	4.36	.24	2.86	.10	2.01	.03	1.19
200					2.95	8.25	.87	4.99	.31	3.26	.13	2.30	.04	1.36
250					4.45	10.31	1.31	6.24	.47	4.08	.20	2.88	.06	1.70
300							1.84	7.48	.65	4.90	.28	3.45	.08	2.04
350							2.44	8.73	.87	5.71	.37	4.03	.10	2.38
400							3.13	9.98	1.12	6.53	.48	4.61	.13	2.71
450							3.89	11.22	1.39	7.35	.59	5.18	.16	3.05
500									1.69	8.16	.72	5.76	.20	3.39
750											1.53	8.64	.42	5.09
1000													.72	6.79
1250													1.09	8.48

Pipe Flow Capacity At 100'

Flow Rate 4 PSI Lost Per 100'		Flow Rate 2 PSI Lost Per 100'	
1/2"	3 GPM	3"	150 GPM
3/4"	7 GPM	4"	325 GPM
1"	14 GPM	5"	550 GPM
1 1/4"	28 GPM	6"	850 GPM
1 1/2"	40 GPM	8"	1,800 GPM
2"	80 GPM		



Field Sprayer Price Sheet

175 Churchtown Rd, Narvon PA 17555
 P 717-768-0747 F 717.768.8350

TERMS: 30 days net, 2% per mo. Added after 30 days, \$5 min.

Quote Date -

Order Date -

PO#	Ph#	Ph#	F#
Name			
Address			

Misc	
Misc	
TOTAL	
Discount: %	
TOTAL	

Frames		
F1503PT	150 gallon 3pt Cat II	<input type="checkbox"/>
F2003PT	200 gallon 3pt Cat II	<input type="checkbox"/>
F3003PT	300 gallon 3pt Cat II	<input type="checkbox"/>
F3003PTHD	300 gallon 3pt HD Cat II or III ¹	<input type="checkbox"/>
F5003PTHD	500 gallon 3pt HD Cat II or III ¹	<input type="checkbox"/>
F200	200 gallon Trailer, 11L Flotation Tire	<input type="checkbox"/>
F300	300 gallon Trailer, 11L Flotation Tire	<input type="checkbox"/>
F300HT	300 gallon trailer, 9.5-24 Tractor tire	<input type="checkbox"/>
F500	500 gallon trailer, 12.4-28 Tractor tire	<input type="checkbox"/>
F750	750 gallon trailer, 12.4-32 Tractor tire	<input type="checkbox"/>
F1000	1000 gallon trailer, 340/85R-38 Tire	<input type="checkbox"/>

Booms		
B30M	30' Manual Fold (trailer models)	<input type="checkbox"/>
B30MEF	30' Manual Fold, w/end fold (3pt models)	<input type="checkbox"/>
B40MEF	40' Manual Fold, w/end fold	<input type="checkbox"/>
B45M	45' Manual Fold, hydraulic leveling	<input type="checkbox"/>
B35H	35' Hyd Fold, Spring Ride	<input type="checkbox"/>
B45H	45' Hyd Fold, Spring Ride	<input type="checkbox"/>
B45AR	45' Hyd Fold, Air Ride	<input type="checkbox"/>
B50AR	50' Hyd Fold, Air Ride	<input type="checkbox"/>
B60AR	60' Hyd, Air Ride	<input type="checkbox"/>
HM	Hyd Multiplier (adds 1 set of hyd)	<input type="checkbox"/>

Boom Plumbing		
NOZ30-20	30' • 20" Spacing • 18 nozzles	<input type="checkbox"/>
NOZ30-2030	30' • 20-30" Spacing • 18 nozzles • 7 w/caps	<input type="checkbox"/>
NOZ35-20	35' • 20" Spacing • 21 nozzles	<input type="checkbox"/>
NOZ35-2030	35' • 20-30" Spacing • 21 nozzles • 8 w/caps	<input type="checkbox"/>
NOZ40-20	40' • 20" Spacing • 24 nozzles	<input type="checkbox"/>
NOZ40-2030	40' • 20-30" Spacing • 24 nozzles • 9 w/caps	<input type="checkbox"/>
NOZ45-20	45' • 20" Spacing • 27 nozzles	<input type="checkbox"/>
NOZ45-2030	45' • 20-30" Spacing • 27 nozzles • 10 w/caps	<input type="checkbox"/>

Air Ride Boom Plumbing, SS Wet Boom		
NOZ45AR-20	45' • 20" Spacing • 27 nozzles	<input type="checkbox"/>
NOZ45AR-2030	45' • 20-30" Spacing • 27 nozzles • 10 w/caps	<input type="checkbox"/>
NOZ45AR-20QD	45' • 20" Spacing • 27 quad nozzles	<input type="checkbox"/>
NOZ45AR-2030QD	45' • 20-30" Spacing • 27 quad nozzles • 10 single w/caps	<input type="checkbox"/>
NOZ50AR-20	50' • 20" Spacing • 30 nozzles	<input type="checkbox"/>
NOZ50AR-2030	50' • 20-30" Spacing • 30 nozzles • 11 w/caps	<input type="checkbox"/>
NOZ50AR-20QD	50' • 20" Spacing • 30 quad nozzles	<input type="checkbox"/>
NOZ50AR-2030QD	50' • 20-30" Spacing • 30 quad nozzles • 11 single w/caps	<input type="checkbox"/>
NOZ60AR-20	60' • 20" Spacing • 36 nozzles	<input type="checkbox"/>
NOZ60AR-2030	60' • 20" Spacing • 36 nozzles • 13 w/caps	<input type="checkbox"/>
NOZ60AR-20QD	60' • 20" Spacing • 36 quad nozzles	<input type="checkbox"/>
NOZ60AR-2030QD	60' • 20-30" Spacing • 36 quad nozzles • 13 single w/caps	<input type="checkbox"/>

Pumps		
PR7C	Hypro 7700C Roller (up to 40' boom)	<input type="checkbox"/>
PR7XL	Hypro 7700XL Roller (up to 40' boom)	<input type="checkbox"/>
PR5C	Hypro 1700C Roller (up to 45' boom)	<input type="checkbox"/>
PR5XL	Hypro 1700XL Roller (up to 45' boom)	<input type="checkbox"/>
PC75H	Ace 75 Hyd Centrifugal (up to 45' boom)	<input type="checkbox"/>
PC150H	Ace 150 Hyd Centrifugal	<input type="checkbox"/>
PC150P	Ace 150 PTO Centrifugal	<input type="checkbox"/>

Controls		
CM3	Manual Control 3- section	<input type="checkbox"/>
CM-TV	Manual Control 3- section (for PC pumps)	<input type="checkbox"/>
CRC3	Remcor Electric - 2100 - 3 Solenoid Valves	<input type="checkbox"/>
CEC3	EC530 3-section Ball Valves	<input type="checkbox"/>
CEC5	EC550 5-section Ball valves	<input type="checkbox"/>
CMT3	Micro Trak AutoRate - 433 Ball valves	<input type="checkbox"/>
CMT5	Micro Trak AutoRate - 435 Ball valves	<input type="checkbox"/>
CTP500	5-section Topcon Rate Control	<input type="checkbox"/>
CT500	5-section Generic Rate Control	<input type="checkbox"/>

Accessories		
ID500NL	5 gal Induction Tank (no lift)	<input type="checkbox"/>
ID500	5 gal Induction Tank	<input type="checkbox"/>
TRIN555	55 gal Total Rinse for F500	<input type="checkbox"/>
TRIN755	75 gal Total Rinse for F750	<input type="checkbox"/>
TRIN100	100 gal Total Rinse for F1000	<input type="checkbox"/>
RIN15-NZ	15 gal Rinse Tank	<input type="checkbox"/>
RIN55-NZ	55 gal Rinse Tank	<input type="checkbox"/>
RINPW	PowerWash, 25' hose ²	<input type="checkbox"/>
RINJ	Jug Rinse ² (requires induction tank)	<input type="checkbox"/>
QF2	2" Quik Fill	<input type="checkbox"/>
QFR	Quik Fill, plumbed to fill rinse tank	<input type="checkbox"/>
LT100	Road lights	<input type="checkbox"/>
LT200	Field and Road lights	<input type="checkbox"/>

Foam Markers and Guidance		
FM4RW	4 gal Richway foam marker	<input type="checkbox"/>
FM10RW	10 gal Richway foam marker	<input type="checkbox"/>
FM4RW	1 gal Richway injection marker	<input type="checkbox"/>

Nozzles		
NOZAIR-<COLOR>AIXR	Tips, includes cap, gasket, screen ³	<input type="checkbox"/>
NOZ-FM	Manual Fence row Nozzle (1 additional tip required)	L <input type="checkbox"/> R <input type="checkbox"/>
<i>Other nozzle tips also available upon request</i>		
NOZ-FE	Electric Fence row Nozzle (1 additional tip required)	L <input type="checkbox"/> R <input type="checkbox"/>

¹Required for AirRide Booms

²Included in Total Rinse units



Produce Sprayer Price Sheet

175 Churchtown Rd, Narvon PA 17555
 P 717-768-0747 F 717.768.8350

TERMS: 30 days net, 2% per mo. Added after 30 days, \$5 min.

Quote Date -

Order Date -

PO#	Ph#	Ph#	F#
Name			
Address			

Misc	
Misc	
TOTAL	
Discount: %	
TOTAL	

Frame	
F1503PT-HL	150 gallon 3pt Cat II <input type="checkbox"/>
F2003PT-HL	200 gallon 3pt Cat II <input type="checkbox"/>
F3003PT-HL	300 gallon 3pt Cat II <input type="checkbox"/>
F200	200 gallon Trailer, 11L tires <input type="checkbox"/>
F300	300 gallon Trailer, 11L tires <input type="checkbox"/>
TW200	Tandem Wheel upgrade, 11L tires <input type="checkbox"/>
F500	500 gallon trailer, 12.4-28 Tire <input type="checkbox"/>
F750	750 gallon trailer, 13.6-28 Tire <input type="checkbox"/>
F1000	1000 gallon trailer, 13.6-36 Tire <input type="checkbox"/>

Booms - includes 90° Hyd lift	
B20MSL	20' Single manual fold, (no boom leveling) <input type="checkbox"/>
B20HSL	20' Single hyd fold <input type="checkbox"/>
B25HSL	25' Single hyd fold <input type="checkbox"/>
B30HSL	30' Single hyd fold <input type="checkbox"/>
BTR	Trac Boom (optional on single boom) <input type="checkbox"/>
B45HL	45' Hyd. fold <input type="checkbox"/>
B60HL	60' Hyd. fold <input type="checkbox"/>
B25-HL5	25' Single Hyd-fold <input type="checkbox"/>
B30-HL5	30' Single Hyd-fold, <input type="checkbox"/>
B60-HL5	60' Single Hyd-fold <input type="checkbox"/>
B60AR-HL5	60' Hyd-fold, AirRide <input type="checkbox"/>
B70AR-HL5	70' Hyd-fold, AirRide <input type="checkbox"/>
HM-E	Hyd Multiplier <input type="checkbox"/>

Boom Plumbing	
NOZ20P-15	20' Single • 15" Spacing • 17-1/2" Nozzles <input type="checkbox"/>
NOZ20P-20	20' Single • 20" Spacing • 13-1/2" Nozzles <input type="checkbox"/>
NOZ25P-15	25' Single • 15" Spacing • 21-1/2" Nozzles <input type="checkbox"/>
NOZ25P-20	25' Single • 20" Spacing • 16-1/2" Nozzles <input type="checkbox"/>
NOZ30P-15	30' Single • 15" Spacing • 25-1/2" Nozzles <input type="checkbox"/>
NOZ30P-20	30' Single • 20" Spacing • 19-1/2" Nozzles <input type="checkbox"/>
NOZ45P-15	45' Double • 15" Spacing • 37-1/2" Nozzles <input type="checkbox"/>
NOZ45P-20	45' Double • 20" Spacing • 27-1/2" Nozzles <input type="checkbox"/>
NOZ60P-12	60' Double • 15" Spacing • 49-1/2" Nozzles <input type="checkbox"/>
NOZ60P-20	60' Double • 20" Spacing • 36-1/2" Nozzles <input type="checkbox"/>
NOXBTRP-15	Trac Boom • 15" Spacing • 5 Nozzles <input type="checkbox"/>
NOZBTRP-20	Trac Boom • 20" Spacing • 4 Nozzles <input type="checkbox"/>

Air Ride Boom Plumbing, SS Wet Boom	
NOZ60AR-15	60' Double 15" Spacing 36-Nozzles <input type="checkbox"/>
NOZ60AR-15QD	60' Double 15" Spacing 36-Quad Nozzles <input type="checkbox"/>
NOZ60AR-20	60' Double 20" Spacing 36-Nozzles <input type="checkbox"/>
NOZ60AR-20QD	60' Double 20" Spacing 36-Quad Nozzles <input type="checkbox"/>
NOZ70AR-15	70' Double 15" Spacing 57-Nozzles <input type="checkbox"/>
NOZ70AR-15QD	70' Double 15" Spacing 57-Quad Nozzles <input type="checkbox"/>
NOZ70AR-20	70' Double 20" Spacing 43-Nozzles <input type="checkbox"/>
NOZ70AR-20QD	70' Double 20" Spacing 43-Quad Nozzles <input type="checkbox"/>

Diaphragm Pumps	
PD193P	CDS - John Blue 19.3 gpm - 218 psi <input type="checkbox"/>
PD185P	CDS - John Blue 18.5 gpm - 580 psi <input type="checkbox"/>
PD230P	CDS - John Blue 23.0 gpm - 725 psi <input type="checkbox"/>
PD401P	CDS - John Blue 39.2 gpm - 725 psi <input type="checkbox"/>

Controls	
CM2BR	Manual Control 2- section, Brass <input type="checkbox"/>
CM3BR	Manual Control 3- section, Brass <input type="checkbox"/>
CMAVBR	Additional Manual Section, Brass <input type="checkbox"/>
CEC2HP	EC530 Electric Control, 462 Ball valves <input type="checkbox"/>
CEC3HP	EC530 Electric Control, 463 Ball valves <input type="checkbox"/>
CEC5HP	EC530 Electric Control, 465 Ball valves <input type="checkbox"/>
CMT3HP	MicroTrak AutoRate, 463 Ball valves <input type="checkbox"/>
CMT5HP	MicroTrak AutoRate, 465 Ball valves <input type="checkbox"/>
CAV460	Additional 460 Ball valve <input type="checkbox"/>
CRV	Remote Master Valve <input type="checkbox"/>

Accessories	
ID500NL	5 gal Induction Tank (no lift) <input type="checkbox"/>
ID500	5 gal Induction Tank <input type="checkbox"/>
TRIN555	55 gal Total Rinse for F500 <input type="checkbox"/>
TRIN755	75 gal Total Rinse for F750 <input type="checkbox"/>
TRIN100	100 gal Total Rinse for F1000 <input type="checkbox"/>
RIN15	15 gal Rinse Tank <input type="checkbox"/>
RIN55	55 gal Rinse Tank <input type="checkbox"/>
RINPW	PowerWash, 25' hose ² <input type="checkbox"/>
RINRN	Rinse Nozzle ² (requires rinse tank) <input type="checkbox"/>
RINJ	Jug Rinse ² (requires induction tank) <input type="checkbox"/>
QF2	2" Quik Fill <input type="checkbox"/>
QFR	Quik Fill, plumbed to fill rinse tank <input type="checkbox"/>
LT300	LED Floodlight w/switch <input type="checkbox"/>
LT100	Road lights <input type="checkbox"/>
LT200	Field and Road lights <input type="checkbox"/>
FM4RW	4gal Richway Foam Marker <input type="checkbox"/>
DT30	30" Drop tube 2 nozzles <input type="checkbox"/>
DT50	50" Drop tube 4 nozzles <input type="checkbox"/>

Nozzles	
NOZTXA-<COLOR>	TXA Hollow Cone Tips, includes cap, gasket, screen <input type="checkbox"/>
<i>other tips also available upon request</i>	
NOZ-BX	Boom Extender-Orange Adjustable tip <input type="checkbox"/>
-Right <input type="checkbox"/> Left <input type="checkbox"/>	



Lawn/Garden/Orchard Sprayer Price Sheet

175 Churchtown Rd, Narvon PA 17555
 P 866.504.1960 F 717.768.8350

TERMS: 30 days net, 2% per mo. Added after 30 days, \$5 min.

Quote Date -

Order Date -

PO#	Ph#	Ph#	F#
Name			
Address			

Misc	
Misc	
TOTAL	
Discount: %	
TOTAL	

Frames		
F153PTWO	15 gal 3 pt Cat I	<input type="checkbox"/>
F153PT	15 gal 3 pt Cat I with 90" lift	<input type="checkbox"/>
F253PT	25 gal 3 pt Cat I	<input type="checkbox"/>
F553PT	55 gal 3 pt Cat I	<input type="checkbox"/>
F853PT	85 gal 3 pt CatI	<input type="checkbox"/>
F25CART	25 gal 3 wheel pull cart	<input type="checkbox"/>
F55T	55 gal trailer, BCS compatible	<input type="checkbox"/>
F85T	85 gal trailer, BCS compatible	<input type="checkbox"/>
FDT3X5	Dump trailer, 36" x 60" 12" sides	<input type="checkbox"/>
FTH	Trailer hitch	<input type="checkbox"/>
FPSW	Pony shafts w/ dolly wheel	<input type="checkbox"/>

Shielded Sprayer <i>(add pump to price)</i>		
F55SH	55 gal shielded unit, 4 shields w/ nozzles	<input type="checkbox"/>
F85SH	85 gal shielded unit, 4 shields w/ nozzles	<input type="checkbox"/>

Pump Options <i>(1 required)</i>		
P12V2WO	JB 12v, 2.2 gpm, 45 psi w/o relief valve	<input type="checkbox"/>
P12V4WO	JB 12v, 4.8 gpm, 45 psi w/o relief valve	<input type="checkbox"/>
PR6C	6 roller Hypro 8 gpm -200 psi, PTO mounted	<input type="checkbox"/>

Handpulled Sprayer <i>(w/ pump)</i>		
F5LG2	5 gl L&G 2.2 gpm, 45 psi, 12v pump, poly gun	<input type="checkbox"/>
F5LG6	5 gal L&G 7 gpm, 120 psi, 12v pump, Arag gun	<input type="checkbox"/>

Boom includes plumbing, add tips		
BWL	90" boom winch lift attachment	<input type="checkbox"/>
B20	20' boom, 13 nozzles w/shutoff	<input type="checkbox"/>
B15	15' boom, 10 nozzles w/shutoff	<input type="checkbox"/>
B125	12' single boom, 10 nozzles w/shutoff	<input type="checkbox"/>
B2X6	(2) 6' booms w/upright position, 8 nozzles	<input type="checkbox"/>
B2X4	(2) 4' booms w/upright position, 6 nozzles	<input type="checkbox"/>

Spray gun, hose, reel		
5062	Arag spray gun	<input type="checkbox"/>
5080	Poly spray gun	<input type="checkbox"/>
HRN	Hose reel, holds 50'	<input type="checkbox"/>
HRC	Hose reel, holds 150'	<input type="checkbox"/>
1591	Hose reel, holds 200'	<input type="checkbox"/>
1006	EPDM hose 3/8" -per feet	<input type="checkbox"/>
1008	EPDM hose 1/2" -per feet	<input type="checkbox"/>
7006	PVC hose 3/8" -per feet	<input type="checkbox"/>
7008	PVC hose 1/2" -per feet	<input type="checkbox"/>

Pumps - include single control		
PD43PTO	JB diaphragm 4.3 gpm -250 psi, PTO mounted	<input type="checkbox"/>
PD43C	JB diaphragm 4.3 gpm -250 psi, Honda engine	<input type="checkbox"/>
PD9PTOC	JB diaphragm 9 gpm - 500 psi, PTO mounted	<input type="checkbox"/>
PD9EC	JB diaphragm 9 gpm -500 psi, Honda engine	<input type="checkbox"/>
PR6XLC	6 roller Hypro 8 gpm -200 psi, PTO mounted	<input type="checkbox"/>
PR4XLC	4 roller Hypro pump, 7 gpm, 100 psi, Honda	<input type="checkbox"/>
PC85EC	Ace centrifugal, Honda engine	<input type="checkbox"/>
P12V2WO	JB 12v, 2.2 gpm, 45 psi w/o relief valve	<input type="checkbox"/>
P12V4WO	JB 12v, 4.8 gpm, 45 psi w/o relief valve	<input type="checkbox"/>
P12V2	JB 12v, 2.2 gpm, 45 psi w/relief valve	<input type="checkbox"/>
P12V4	JB 12v, 4.8 gpm, 45 psi w/relief valve	<input type="checkbox"/>
P12V7	Remco 12v, 7 gpm, 120 psi w/relief valve	<input type="checkbox"/>
P12V4C	JB 12v, 4.8 gpm, 45 psi w/control	<input type="checkbox"/>
AKSC	12v remote pressure control, JB pump	<input type="checkbox"/>

Applicator Units		
15SY	15 gal tank, choose 12v pump	<input type="checkbox"/>
25SY	25 gal tank, choose 12v pump	<input type="checkbox"/>
40SY	40 gal tank, choose 12v pump	<input type="checkbox"/>
FHP12v	3 wheeled applicator cart	<input type="checkbox"/>
FAPWC	Wheelbarrow applicator cart	<input type="checkbox"/>
FAPSH	Single row shielded cart w/2 nozzles	<input type="checkbox"/>

Nozzles		
NOZAXR-<COLOR>AIXR	Tips air-induction fan	<input type="checkbox"/>
	- Specify size -gpa <input type="text"/> -mph <input type="text"/>	
NOZXRC	XRC tips fan - specify size	<input type="checkbox"/>
	- Specify size -gpa <input type="text"/> -mph <input type="text"/>	
NOZTXA	Tips TXA hollow cone - specify size	<input type="checkbox"/>
	- Specify size -gpa <input type="text"/> -mph <input type="text"/>	
NOZBL	Boomless nozzle, 10 - 18' wide	<input type="checkbox"/>
	- Specify size -gpa <input type="text"/> -mph <input type="text"/>	

Index

Symbols

4-Way Spider 54

A

Adjuvants 35

Anchor Bags 5

Aqua Spray Sticks 54

B

Backpack Sprayer 87

Bags 101

Battery 103

Beans 9

Berry Flat 7

Biostimulants 31

Bird Netting 97

Bird Scare Tape 97

Brass Hose Ends 66

Broccoli 10

C

Cabbage 10

Camlock Fittings 101, 102

Cantaloupes 11

CapSil 33

Carrots 11

Cauliflower 11, 12

Chemicals 40

Clear Embossed Film 82

Clear Perforated Row Cover 8

Coconut Coir 29

Compact Raised Bed Layer 82

Conveyor 90

Corn 12, 13, 14

Counter 101

Coveralls 101

Cucumber 14

Crop Production Aids 33

D

DAN Foggers 54

Disinfectants 36

Drain Valve 67

Drip Tape 78

Drip Tape Tee 62

Drum Pump 39

Dutch Bucket 29

E

Eggplant 15

Electric Pumps 59

Electric Sprayers 86

F

Field Injectors 61

Filters 60

Fertilizers 30

Flags 100

Flowmeter 61

G

Garden Hose 66

Garden Hose Fittings 64

Gate Valves 67

Goggles 101

Gourds 15

Grafting Clips 96

Ground Cover 5

H

Hand Planter 100

Hanging Tubes 54

Herbicides 42

Hobby Greenhouse 106

Hoe 101

Hole Punches 63

Hose Clamps 103

Hosing 76, 77

I

Injectors 61

Insecticides 43

Irrigation 46

Irrigation Controllers 55

K

Kale 15

L

Lettuce 16

Liquid Fertilizers 36

M

Mazzei 61

Melons 11

Microembossed Film 82, 83

Micronutrients 32

Micro Sprinkler 52

Mini Wobbler 46

Mulch Bed Planters 80

Mulch Lifters 94

Mulch Plastic 82

N

NaanDanJain Irrigation 52

Nitrile Rubber Chemical Gloves
102

O

Onions 16, 17
Orchard Tubing 77
Orchard Tubing Punch 63
Organic Fertilizers 34

P

Packing Tape 98
Peas 17, 18
Peppers 19
pH Test Kit 101
Pipe 76
Pipe Cement 74
Pipe Joint Compound 74
Poly Pipe 74
Potatoes 19, 20
Power Loc 74
Pressure Gauges 68
Pressure Regulators 49
Produce Bag 7
Propagation Controllers 56
Pruner 105
Pumpkins 21, 24
Pumps 56
Punches 63
PVC Ball Valves 67
PVC SCH40 Pipe 76
PVC Unions 74

R

Radish 24
Regulator Assembly 61
Respirator 103
Rubber Bands 97
Rubber Gaskets 100

S

Sand Filter 59
Seeder 106
Senninger 48
Shrink Wrap 98
Shuttle Bin 7
Soil Moisture Indicator 104
Specialty Macronutrients 30
Spinach 25
Sprayers 85
Sprinklers 46
Sprinkler Stands 54
Squash 27, 28
Stake Driver 104
Stakes 103
Standard Macronutrients 30
Steel Fittings 68
Stickers 100
Stoves 5
Suction Hose 77
Suction Strainers 68
Syphon Mixer 54

T

Tags 101
Tank Cleaner 34
Tater Rip Plows 107
Teflon Tape 72
Terra Grow 33
T-Growth Products 36
Thermometer 98
Tie Wire Twister 98
Tomato Cages 96
Tomatoes 25
Tomato Twine 96
T Sprays 47

Turnips 26

Twine 96

V

Vegetable Seed Planter 106
Vine Clips 96
Vinyl Tubing 76

W

Water Breakers 98
Water Filters 59
Watermelon 26, 27
Water Timer 98
Water Wheel Planter 84
White Pumpkins 24
Wire Hoops 5
Wobbler 46
Wonder Waterer 98
Wooden Baskets 7
Wooden Trays 7
Wood Stakes 103

Z

ZON LP Gas Cannon 95
Zucchini 27, 28



2024/2025 Sales Finance Program

Low cash or no cash? Now is the perfect time to purchase supplies, with the best deals of the season with your **Multi-Use Account** by John Deere Financial. Put your purchasing power to work at Martin's Produce Supplies. We've got everything you need to keep your business moving forward.

Program	Program Period	Minimum Initial Purchase
No-Payments / No-Interest for 180 Days	JD Credit Dec 1 - Jan 5, 2024	\$500

Program Requirements

To take advantage of this great offer, you must have a Multi-Use Account. You can call 1-800-433-8964 to request a credit limit increase on your Multi-Use Account.

How to Apply

If you don't have an account, don't worry. John Deere Financial gives you easy ways to apply:

- Online at JohnDeereFinancial.com/MultiUseApply
- Call 1-800-433-8964 to have an application mailed to you

For more information, contact Martin's Supply at 717-532-5918.



¹Offer valid on qualifying purchases made between September 1, 2024 to January 10, 2025 and is subject to approved credit on a Multi-Use Account, a service of John Deere Financial, f.s.b. For agricultural/commercial use only. After the promotional period, interest charges will begin to accrue at the regular Multi-Use Account rate. \$500 minimum purchase required. Available at participating merchants, see your local merchant for complete details.



627 Britton Road
Shippensburg PA 17257

Tel: 888.381.8641
Fax: 717.532.5872

Bringing you the best in greenhouse & produce supplies!

